

HYBRID VIDEO RECORDER 32-CHANNEL MODEL USER'S MANUAL

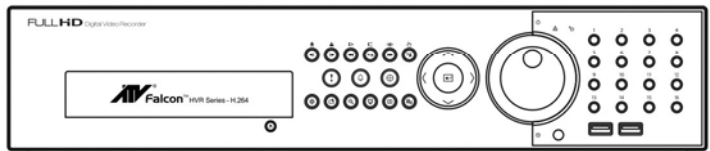



WARNING

RISK OF ELECTRIC SHOCK
DO NOT OPEN



WARNING: TO REDUCE THE RISK OF ELECTRIC SHOCK,
DO NOT REMOVE COVER (OR BACK).
NO USER-SERVICEABLE PARTS INSIDE.
REFER SERVICING TO QUALIFIED
SERVICE PERSONNEL.



The lightning flash with arrowhead symbol, within an equilateral triangle, is intended to alert the user to the presence of uninsulated "dangerous voltage" within the product's enclosure that may be of sufficient magnitude to constitute a risk of electric shock.



The exclamation point within an equilateral triangle is intended to alert the user to the presence of important operating and maintenance (servicing) instructions in the literature accompanying the appliance.

COMPLIANCE NOTICE OF FCC:

THIS EQUIPMENT HAS BEEN TESTED AND FOUND TO COMPLY WITH THE LIMITS FOR A CLASS A DIGITAL DEVICE, PURSUANT TO PART 15 OF THE FCC RULES. THESE LIMITS ARE DESIGNED TO PROVIDE REASONABLE PROTECTION AGAINST HARMFUL INTERFERENCE WHEN THE EQUIPMENT IS OPERATED IN A COMMERCIAL ENVIRONMENT. THIS EQUIPMENT GENERATES, USES, AND CAN RADIATE RADIO FREQUENCY ENERGY AND IF NOT INSTALLED AND USED IN ACCORDANCE WITH THE INSTRUCTION MANUAL, MAY CAUSE HARMFUL INTERFERENCE TO RADIO COMMUNICATIONS. OPERATION OF THIS EQUIPMENT IN A RESIDENTIAL AREA IS LIKELY TO CAUSE HARMFUL INTERFERENCE, IN WHICH CASE USERS WILL BE REQUIRED TO CORRECT THE INTERFERENCE AT THEIR OWN EXPENSE.

WARNING: CHANGES OR MODIFICATIONS NOT EXPRESSLY APPROVED BY THE PARTY RESPONSIBLE FOR COMPLIANCE COULD VOID THE USER'S AUTHORITY TO OPERATE THE EQUIPMENT.

THIS CLASS OF DIGITAL APPARATUS MEETS ALL REQUIREMENTS OF THE CANADIAN INTERFERENCE-CAUSING EQUIPMENT REGULATIONS.

The information in this manual is believed to be accurate as of the date of publication. We are not responsible for any problems resulting from the use thereof. The information contained herein is subject to change without notice. Revisions or new editions to this publication may be issued to incorporate such changes.

The software included in this product contains some Open Sources. You may obtain the complete corresponding source code from us. See the Open Source Guide on the software CD (*OpenSourceGuide\OpenSourceGuide.pdf*) or as a printed document included along with the User's Manual.

Important Safeguards

1. Read Instructions

All the safety and operating instructions should be read before the appliance is operated.

2. Retain Instructions

The safety and operating instructions should be retained for future reference.

3. Cleaning

Unplug this equipment from the wall outlet before cleaning it. Do not use liquid aerosol cleaners. Use a damp soft cloth for cleaning.

4. Attachments

Never add any attachments and/or equipment without the approval of the manufacturer as such additions may result in the risk of fire, electric shock or other personal injury.

5. Water and/or Moisture

Do not use this equipment near water or in contact with water.

6. Ventilation

Place this equipment only in an upright position. This equipment has an open-frame Switching Mode Power Supply (SMPS), which can cause a fire or electric shock if anything is inserted through the ventilation holes on the side of the equipment.

7. Accessories

Do not place this equipment on an unstable cart, stand or table. The equipment may fall, causing serious injury to a child or adult, and serious damage to the equipment. Wall or shelf mounting should follow the manufacturer's instructions, and should use a mounting kit approved by the manufacturer.



This equipment and cart combination should be moved with care. Quick stops, excessive force, and uneven surfaces may cause the equipment and cart combination to overturn.

8. Power Sources

This equipment should be operated only from the type of power source indicated on the marking label. If you are not sure of the type of power, please consult your equipment dealer or local power company.

9. Power Cords

Operator or installer must remove power and TNT connections before handling the equipment.

10. Lightning

For added protection for this equipment during a lightning storm, or when it is left unattended and unused for long periods of time, unplug it from the wall outlet and disconnect the antenna or cable system. This will prevent damage to the equipment due to lightning and power-line surges.

11. Overloading

Do not overload wall outlets and extension cords as this can result in the risk of fire or electric shock.

12. Objects and Liquids

Never push objects of any kind through openings of this equipment as they may touch dangerous voltage points or short out parts that could result in a fire or electric shock. Never spill liquid of any kind on the equipment.

13. Servicing

Do not attempt to service this equipment yourself. Refer all servicing to qualified service personnel.

14. Damage requiring Service

Unplug this equipment from the wall outlet and refer servicing to qualified service personnel under the following conditions:

- A. When the power-supply cord or the plug has been damaged.
- B. If liquid is spilled, or objects have fallen into the equipment.
- C. If the equipment has been exposed to rain or water.
- D. If the equipment does not operate normally by following the operating instructions, adjust only those controls that are covered by the operating instructions as an improper adjustment of other controls may result in damage and will often require extensive work by a qualified technician to restore the equipment to its normal operation.
- E. If the equipment has been dropped, or the cabinet damaged.
- F. When the equipment exhibits a distinct change in performance — this indicates a need for service.

15. Replacement Parts

When replacement parts are required, be sure the service technician has used replacement parts specified by the manufacturer or that have the same characteristics as the original part. Unauthorized substitutions may result in fire, electric shock or other hazards.

16. Safety Check

Upon completion of any service or repairs to this equipment, ask the service technician to perform safety checks to determine that the equipment is in proper operating condition.

17. Field Installation

This installation should be made by a qualified service person and should conform to all local codes.

18. Correct Batteries

Warning: Risk of explosion if battery is replaced by an incorrect type. Dispose of used batteries according to the instructions.

19. Tmra

A manufacturer's maximum recommended ambient temperature (Tmra) for the equipment must be specified so that the customer and installer may determine a suitable maximum operating environment for the equipment.

20. Elevated Operating Ambient Temperature

If installed in a closed or multi-unit rack assembly, the operating ambient temperature of the rack environment may be greater than room ambient. Therefore, consideration should be given to installing the equipment in an environment compatible with the manufacturer's maximum rated ambient temperature (Tmra).

21. Reduced Air Flow

Installation of the equipment in the rack should be such that the amount of airflow required for safe operation of the equipment is not compromised.

22. Mechanical Loading

Mounting of the equipment in the rack should be such that a hazardous condition is not caused by uneven mechanical loading.

23. Circuit Overloading

Consideration should be given to connection of the equipment to supply circuit and the effect that overloading of circuits might have on over current protection and supply wiring. Appropriate consideration of equipment nameplate ratings should be used when addressing this concern.

24. Reliable Earthing (Grounding)

Reliable grounding of rack mounted equipment should be maintained. Particular attention should be given to supply connections other than direct connections to the branch circuit (e.g., use of power strips).

WEEE (Waste Electrical & Electronic Equipment)

Correct Disposal of This Product

(Applicable in the European Union and other European countries with separate collection systems)



This marking shown on the product or its literature, indicates that it should not be disposed with other household wastes at the end of its working life. To prevent possible harm to the environment or human health from uncontrolled waste disposal, please separate this from other types of wastes and recycle it responsibly to promote the sustainable reuse of material resources.

Household users should contact either the retailer where they purchased this product, or their local government office, for details of where and how they can take this item for environmentally safe recycling.

Business users should contact their supplier and check the terms and conditions of the purchase contract. This product should not be mixed with other commercial wastes for disposal.

Table of Contents

Chapter 1 — Introduction	1
Feature	1
Technical Overview	1
Chapter 2 — Installation	3
Package Contents	3
Required Installation Tools	3
Video Input	3
Video Loop Through	4
Factory Reset Switch	4
HD/SD Out Selector	4
Network Port	4
iSCSI Port	4
eSATA Port	5
RS232C Port	5
RS485 Port	5
Alarm Input/Output	5
Audio In/Out	6
Video Out	6
Power Cord Connector	7
Chapter 3 — Configuration	9
Front Panel Controls	9
Camera Buttons (1 to 16)	10
LED	10
Jog Dial, Shuttle Ring	10
Enter Button	11
Arrow Buttons	11
Playback Buttons	11
PTZ Button	11
Alarm Button	11
Panic Button	11
Freeze Button	11
Bookmark Button	11
ZOOM Button	12
Monitor Button	12
Display Button	12
Menu Button	12
USB Port	12
ID Button on Remote Control	12
Sequence Button on Remote Control	12
Clip Copy Button on Remote Control	12
Turning on the Power	13
Initial Unit Setup	13
Setup Screen	14
System Setup	14
General	14
Date/Time	17

User	18
Storage	20
Monitoring	21
Recording Setup	22
General	22
Schedule	23
Pre-Event	25
Archive	26
Network Setup	27
General	27
IP Address	29
DVRNS	30
RTSP	32
Notification	33
iSCSI	35
Event Setup	36
Motion	36
Alarm-In	38
Video Loss	39
Video Blind	39
Text-In	40
Network	42
Device Setup	42
Local Audio	42
Network Audio	43
Alarm-Out	44
Remote Control	44
Display Setup	45
OSD	45
Primary Monitor	46
Secondary Monitor	47
Spot Monitor	48
Status Setup	49
Event	49
Storage	50
Camera Setup	51
General	51
PTZ	52
Network Camera	53
Chapter 4 — Operation	59
Turning on the Power	59
Live Monitoring	59
Live Monitoring Menu	60
Active Cameo Mode	62
Zoom Mode	62
PTZ Mode	62
Event Monitoring	63
Covert Camera	64
Spot Monitoring	64
Recording Video	64

Panic Recording	65
Recording Audio	65
Playing Recorded Video	65
Searching Video.....	66
Search Menu	67
Event Log Search	69
Record Table Search.....	71
Motion Search	72
Text-In Search	74
Bookmarks.....	75
Clip-Copy	75
Print	77
Disk Mirroring.....	78
Appendix	79
USB Hard Disk Drive Preparation.....	79
Text-In Search Examples.....	79
Search Example I	79
Search Example II	80
ATVision.....	81
Web Monitoring Mode	82
Web Search Mode.....	83
Time Overlap	84
Remote Setup of Network Devices.....	85
Connector Pin Outs.....	88
RS485 Connector Pin Outs	88
I/O Connector Pin Outs	88
Map of Screens.....	89
Troubleshooting	90
System Log Notices	90
Error Code Notices	91
Specifications.....	92

List of Illustrations

Figure 1 : Typical DVR installation.....	2
Figure 2 : DVR rear panel.....	3
Figure 3 : DVR front panel.....	9
Figure 4 : Infrared remote control.....	10
Figure 5 : Login screen.....	13
Figure 6 : Logout screen.....	13
Figure 7 : Setup screen.....	14
Figure 8 : System – General setup screen.....	15
Figure 9 : System – Date/Time setup screen.....	17
Figure 10 : System – User setup screen.....	18
Figure 11 : System – Storage setup screen.....	20
Figure 12 : System – Monitoring setup screen.....	21
Figure 13 : Record – General setup screen.....	22

Figure 14 : Record – Schedule setup screen.....23

Figure 15 : Schedule – Settings (Advanced Mode) setup screen.24

Figure 16 : Record – Pre-Event setup screen.....26

Figure 17 : Record – Archive setup screen.....26

Figure 18 : Network – General setup screen.....27

Figure 19 : Network – IP Address (Manual) setup screen.....29

Figure 20 : Network – DVRNS setup screen.....31

Figure 21 : Network – RTSP setup screen.....32

Figure 22 : Network – Notification setup screen.....33

Figure 23 : Network – iSCSI setup screen.....35

Figure 24 : Event – Motion setup screen.....37

Figure 25 : Event – Alarm-In setup screen.....38

Figure 26 : Event – Video Loss setup screen.....39

Figure 27 : Event – Video Blind setup screen.....39

Figure 28 : Event – Text-In setup screen.....40

Figure 29 : Text-In Device screen.....41

Figure 30 : Event – Network setup screen.....42

Figure 31 : Device – Audio setup screen.....43

Figure 32 : Device – Network Audio setup screen.....43

Figure 33 : Device – Alarm-Out setup screen.....44

Figure 34 : Device – Remote Control setup screen.....45

Figure 35 : Display – OSD setup screen.....45

Figure 36 : Display – Primary Monitor setup screen.....46

Figure 37 : Display – Secondary Monitor setup screen.....48

Figure 38 : Display – Spot Monitor setup screen.....49

Figure 39 : Status – Event setup screen.....50

Figure 40 : Status – Storage setup screen.....51

Figure 41 : Camera – General setup screen.....52

Figure 42 : Camera – PTZ setup screen.....52

Figure 43 : Camera – Network Camera setup screen.....53

Figure 44 : Live Monitoring menu.....59

Figure 45 : PTZ Select Camera menu.....62

Figure 46 : PTZ Preset menu.....63

Figure 47 : Select Playback Camera menu.....65

Figure 48 : Search menu.....67

Figure 49 : Event Log Search screen.....69

Figure 50 : Record Table Search screen.....71

Figure 51 : Motion Search screen.....72

Figure 52 : Text-In Search screen.....74

Figure 53 : Bookmarks screen.....75

Figure 54 : Clip-Copy screen.....76

Figure 55 : Print screen.....77

Figure 56 : System – Storage setup screen.....78

Chapter 1 — Introduction

Feature

Your color digital video recorder (DVR) provides recording capabilities for 32 camera inputs (16 network video inputs included). It provides exceptional picture quality in both live and playback modes, and offers the following features:

NOTE: Your DVR can record both analog CCTV video input and network video input. For a list of supported network devices (network cameras and network video transmitters), contact your installer or distributor.

- 16 Composite Video Input Connectors and 16 Network Video Inputs
- Compatible with Color (NTSC or PAL) and B&W (CCIR and EIA-170) Video Sources
- Auto Detection for NTSC and PAL
- H.264 Codec
- Multiple Monitor Connectors: 1 HDMI, 2 VGA, 2 BNC Video Out, 1 Spot
- Multiple Search Engines (Date/Time, Record Table, Event)
- Real-time Recording (480/400 Images per Second (NTSC/PAL) with Very High (D1) Resolution)
- “Loop-Through” Video Connectors
- Continuous Recording in Disk Overwrite Mode
- Pentaplex Functionality (Monitoring, Recording, Playback, Archiving and Transmission at the same time)
- Video Archiving via eSATA Interface
- 2 USB 2.0 Ports
- Continues Recording while Archiving, Transmitting to Remote Site and during Playback
- User-friendly Graphical User Interface (GUI) Menu System
- Multiple Recording Modes (Time-lapse, Pre-event, Event and Panic)
- Two-way Audio Communication
- 16-Channel Audio Recording and 1-Channel Audio Playback
- Text Input for ATM and POS
- Alarm Connections Include: Input, Output and Reset Input
- Built-in Alarm Buzzer
- Live or Recorded Video Access via Ethernet
- Time Synchronization using industry standard protocol
- Built-in DVD RW Drive
- IR Remote Control
- Self-diagnostics with automatic notification including hard disk drive S.M.A.R.T. protocol

Technical Overview

In addition to replacing both a time-lapse VCR and a multiplexer in a security installation, your DVR has many features that make it much more powerful and easier to use than even the most advanced VCR.

The DVR converts analog NTSC or PAL video to digital images and records them on a hard disk drive. Using a hard disk drive allows you to access recorded video almost instantaneously; there is no need to rewind tape. The technology also allows you to view recorded video while the DVR continues recording video.

Digitally recorded video has several advantages over analog video recorded on tape. There is no need to adjust tracking. You can freeze frames, fast forward, fast reverse, slow forward and slow reverse without image streaking or tearing. Digital video can be indexed by time or events, and you can instantly view video after selecting the time or event.

Your DVR can be set up for event or time-lapse recording. You can define times to record, and the schedule can change for different days of the week and user defined holidays.

The DVR can be set up to alert you when the hard disk drive is full, or it can be set to record over the oldest video once the disk is full.

Your DVR supports disk mirroring functions to prevent any unexpected loss of recorded video data that might be caused by disk damage or corruption.

Your DVR uses a proprietary encryption scheme making it nearly impossible to alter video.

Your DVR can be used to monitor video from network video transmitters and/or network cameras, record monitored video and play back recorded video.

You can view video and control your DVR remotely by connecting via Ethernet. There are eSATA and iSCSI ports that can be used to record or archive (eSATA interface only) video to external hard disk drives, and there are two USB ports that can be used to upgrade the system or copy video clips to external hard disk and flash drives.

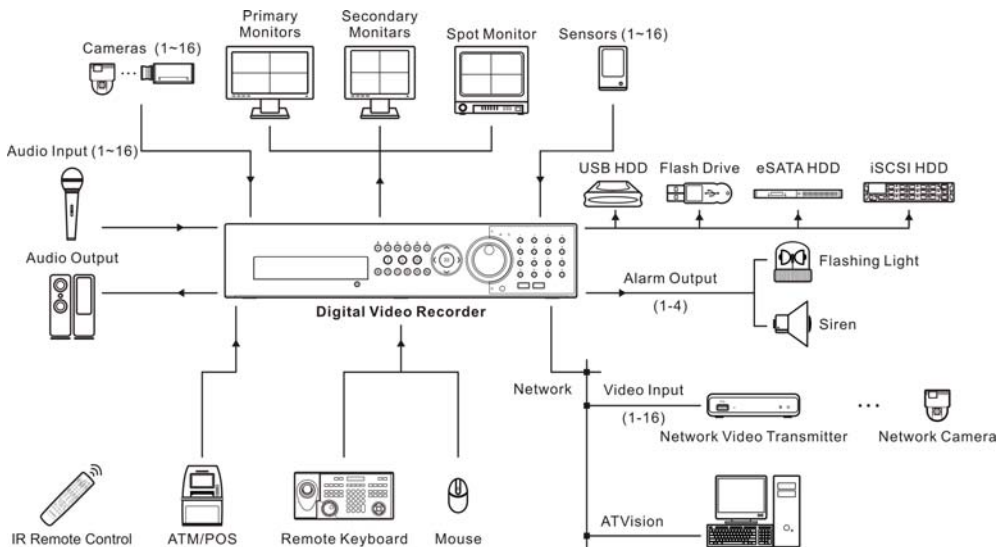

Figure 1 : Typical DVR installation.

Chapter 2 — Installation

Package Contents

The package contains the following:

- Digital Video Recorder
- Power Cord
- User's Manual (This Document)
- ATVision Software CD and User's Manual
- Rack-mount Kit
- Assembly Screws for Adding Hard Disk Drives
- SATA Cables
- Audio Extension Cable
- USB Mouse
- Infrared Remote Control

Required Installation Tools

No special tools are required to install the DVR. Refer to the installation manuals for the other items that make up part of your system.

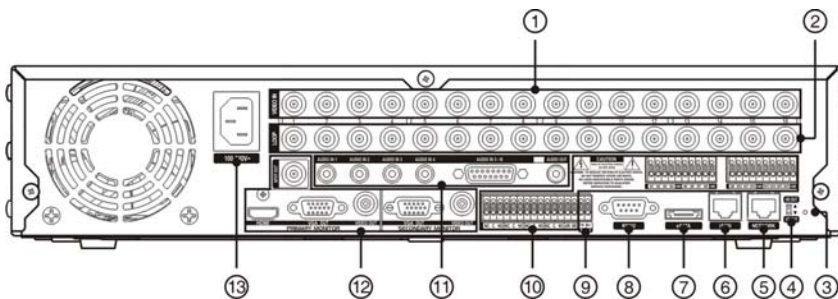

Figure 2 : DVR rear panel.

- | | | |
|------------------------|----------------------|------------------------|
| ① Video Input | ② Video Loop Through | ③ Factory Reset Switch |
| ④ HD/SD Out Selector | ⑤ Network Port | ⑥ iSCSI Port |
| ⑦ eSATA Port | ⑧ RS232C Port | ⑨ RS485 Port |
| ⑩ Alarm Input/Output | ⑪ Audio In/Out | ⑫ Video Out |
| ⑬ Power Cord Connector | | |

Your DVR can be used with either NTSC or PAL equipment.

NOTE: You cannot mix NTSC and PAL equipment. For example you cannot use a PAL camera and an NTSC monitor.

Video Input



Connect the coaxial cables from the video sources to the BNC Video In connectors.

Video Loop Through



If you would like to connect your video source to another device, you can use the Loop BNC connectors.

NOTE: The Loop BNC connectors are auto terminated. Do NOT connect a cable to the Loop BNC unless it is connected to a terminated device because it will cause poor quality video.

Factory Reset Switch



The DVR has a Factory Reset switch to the right of the HD/SD Out selector on the rear panel. This switch will only be used on the rare occasions that you want to return all the settings to the original factory settings.

CAUTION: When using the *Factory Reset*, you will lose any settings you have saved.

To reset the unit, you will need a straightened paperclip:

1. Turn the DVR off.
2. Turn it on again.
3. While the DVR is initializing, the front panel LEDs will blink. When the front panel LEDs blink, poke the straightened paperclip into the unlabeled hole to the right of the HD/SD Out selector.
4. Hold the reset switch until the DVR's internal buzzer sounds twice.
5. Release the reset switch. All of the DVR's settings are now at the original settings it had when it left the factory.

HD/SD Out Selector



An HD/SD Out selector is provided to select the monitor display mode between HD (High Definition) and SD (Standard Definition). Setting the selector to the HD OUT position sends HD video to the connected HDMI and VGA monitors, and setting to the SD OUT position sends SD video to the connected composite BNC monitor.

Network Port



The DVR can be networked using the 10Mb/1Gb Ethernet connector. Connect a Cat5 cable with an RJ-45 jack to the DVR connector. The DVR can be networked with network cameras or video transmitters for remote monitoring and recording, and can also be networked with a computer for remote monitoring, searching, configuration and software upgrades. See *Chapter 3 – Configuration* for configuring the Ethernet connections.

CAUTION: The network connector is not designed to be connected directly with cable or wire intended for outdoor use.

iSCSI Port



An iSCSI port is provided to connect external storage devices for recording video. Connect the external iSCSI hard disk drive (RAID) cable to the RJ-45 Ethernet port.

NOTE: Up to eight iSCSI volumes (or nodes) can be connected to the DVR.

CAUTION: Do NOT connect or disconnect iSCSI devices while the DVR power is on. The DVR must be powered down to connect or disconnect iSCSI devices. Power up iSCSI devices so they are ready for operation before powering up the DVR. Power down iSCSI devices after powering down the DVR and then disconnect iSCSI devices.

CAUTION: When recording video on an iSCSI device, the recoding speed might decrease and the DVR system performance might be affected if network devices (network cameras and network video transmitters) are connected.

eSATA Port



An eSATA port is provided to connect external storage devices for recording or archiving video. Connect the external eSATA hard disk drive (RAID) cable to the eSATA port.

CAUTION: Do NOT connect or disconnect eSATA devices while the DVR power is on. The DVR must be powered down to connect or disconnect eSATA devices. Power up eSATA devices so they are ready for operation before powering up the DVR. Power down eSATA devices after powering down the DVR and then disconnect eSATA devices.

RS232C Port



An RS232 port is provided to connect a remote control keyboard.

RS485 Port



The DVR can be controlled remotely by an external device or control system, such as a control keyboard, using RS485 half-duplex serial communications signals. The RS485 connector can also be used to control PTZ (pan, tilt, zoom) cameras. Connect RX+/TX+ and RX-/TX- of the control system to the + and - (respectively) of the DVR. See *Chapter 3 – Configuration* and the PTZ camera or remote controller manufacturer's manual for configuring the RS485 connection.

Alarm Input/Output



NOTE: To make connections on the Alarm Connector Strip, press and hold the button and insert the wire in the hole below the button. After releasing the button, tug gently on the wire to make certain it is connected. To disconnect a wire, press and hold the button above the wire and pull out the wire.

AI 1 to 16 (Alarm-In): You can use external devices to signal the DVR to react to events. Mechanical or electrical switches can be wired to the AI (Alarm-In) and GND (Ground) connectors. The threshold voltage of electrical switches for NC (Normally Closed) is above 2.4V and for NO (Normally Open) is below 0.3V, and should be stable at least 0.5 seconds to be detected. The voltage range of alarm input is from 0V to 5V. See *Chapter 3 – Configuration* for configuring alarm input.

GND (Ground): Connect the ground side of the Alarm input and/or alarm output to the GND connector.

NOTE: All the connectors marked GND are common.

NC/NO (Relay Alarm Outputs): The DVR can activate external devices such as buzzers or lights. Connect the device to the C (Common) and NC (Normally Closed) or C and NO (Normally Open) connectors. NC/NO is a relay output which sinks 2A@125VAC and 1A@30VDC. See *Chapter 3 – Configuration* for configuring alarm output.

ARI (Alarm Reset In): An external signal to the Alarm Reset In can be used to reset both the Alarm Out signal and the DVR's internal buzzer. Mechanical or electrical switches can be wired to the ARI (Alarm Reset In) and GND (Ground) connectors. The threshold voltage is below 0.3V and should be stable at least 0.5 seconds to be detected. Connect the wires to the ARI and GND connectors.

Audio In/Out



Your DVR can record audio from up to 16 sources. Connect the audio sources to Audio In 1 to Audio In 16 as needed using RCA jacks. Connect Audio Out to your amplifier. Use the provided audio extension cable to connect the audio sources to Audio In 5 to 16.

NOTE: It is the user's responsibility to determine if local laws and regulations permit recording audio.

The DVR does not have amplified audio output, so you will need a speaker with an amplifier. The DVR does not have a pre-amplifier for audio input, so the audio input should be from an amplified source, not directly from a microphone.

Video Out

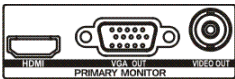

An HDMI (High-Definition Multimedia Interface) connector is provided so that you can use an HDMI monitor as your primary monitor when in the HD (High Definition) display mode, and a VGA connector is provided so that you can use a standard, multi-sync computer monitor as your primary monitor. Use the cable supplied with your monitor to connect it to the DVR.

When in the SD (Standard Definition) display mode, connect the primary monitor to the Video Out connector. It is best to use the monitor as a subsidiary of the HD display output otherwise the monitor might have display limitations.

NOTE: Monitoring and playing back video from network devices is supported only on the primary monitors.

When using HDMI monitors, change the monitor display mode to HD mode by setting the HD/SD Out selector on the rear panel to the *HD OUT* position. HDMI video out will only be enabled in the HD display mode.

VGA video out on the primary monitor will be disabled in the SD display mode.

Composite (BNC) video out on the primary monitor will be disabled in the HD display mode.

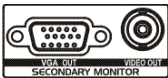

A VGA connector is provided so that you can use a standard, multi-sync computer monitor as your secondary monitor. Use the cable supplied with your monitor to connect it to the DVR.

Connect the secondary monitor to the Video Out connector.



Connect the spot monitor to the SPOT connector as needed.

Monitor Connection Examples:

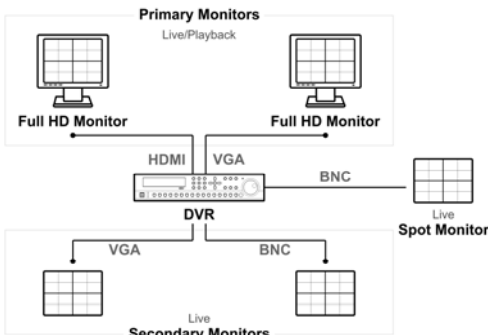

< HD Display Mode >

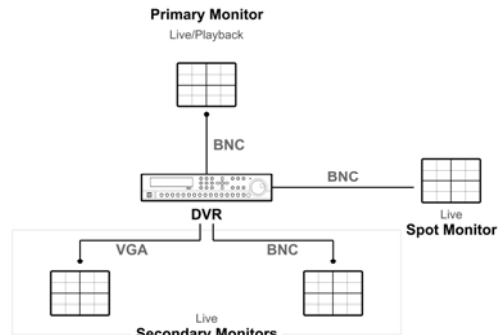

< SD Display Mode >

NOTE: Connect the monitor before the DVR boots so that video can be displayed on the monitor with the resolution you have set during system setup. If you want to use both the HDMI and VGA Primary Monitor connectors, one of the monitors should be connected before the DVR boots, and the other monitor should be connected after the DVR boots.

Power Cord Connector



Connect the AC power cord to the DVR and then to a wall outlet.

WARNING: ROUTE POWER CORDS SO THAT THEY ARE NOT A TRIPPING HAZARD. MAKE CERTAIN THE POWER CORD WILL NOT BE PINCHED OR ABRADED BY FURNITURE. DO NOT INSTALL POWER CORDS UNDER RUGS OR CARPET. THE POWER CORD HAS A GROUNDING PIN. IF YOUR POWER OUTLET DOES NOT HAVE A GROUNDING PIN RECEPTACLE, DO NOT MODIFY THE PLUG. DO NOT OVERLOAD THE CIRCUIT BY PLUGGING TOO MANY DEVICES IN TO ONE CIRCUIT.

Your DVR is now ready to operate. Refer to *Chapter 3 — Configuration* and *Chapter 4 — Operation*.

Chapter 3 — Configuration

NOTE: Your DVR should be completely installed before proceeding. Refer to *Chapter 2 — Installation*.

Front Panel Controls

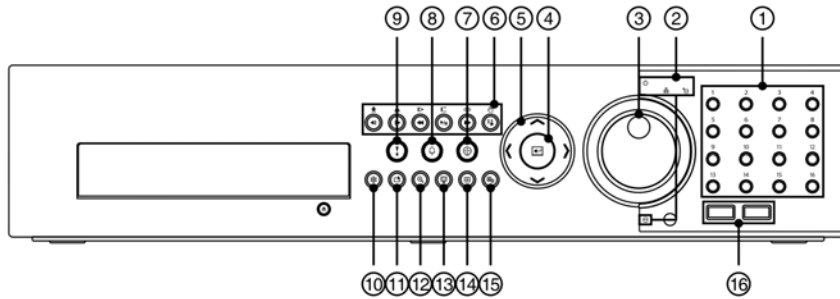

Figure 3 : DVR front panel.

- | | | | |
|------------------|--------------------|--------------------------|----------------|
| ① Camera Buttons | ② LED | ③ Jog Dial, Shuttle Ring | ④ Enter Button |
| ⑤ Arrow Buttons | ⑥ Playback Buttons | ⑦ PTZ Button | ⑧ Alarm Button |
| ⑨ Panic Button | ⑩ Freeze Button | ⑪ Bookmark Button | ⑫ Zoom Button |
| ⑬ Monitor Button | ⑭ Display Button | ⑮ Menu Button | ⑯ USB Port |

The front panel looks and operates much like a VCR combined with a multiplexer. Many of the buttons have multiple functions. The buttons on the infrared remote control, while laid out differently, perform the same functions as those on the front panel. The following describes each button and control. Take a few minutes to review the descriptions. You will use these to initially set up your DVR and for daily operations.

NOTE: The infrared sensor on the DVR is just to the left of USB ports. Make certain that nothing blocks the sensor, or the remote control will not function properly.

When you use wireless communication devices (such as Wi-Fi or Bluetooth) near the DVR, the remote control might not function properly.

You can also use a USB mouse to navigate through the screens and menus much like you would on a computer.

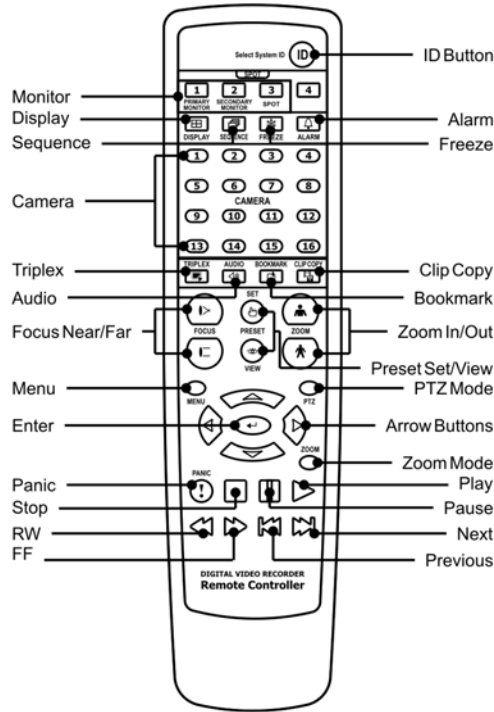

Figure 4 : Infrared remote control.

NOTE: For simplicity, the button descriptions in this manual refer to the front panel buttons.

Camera Buttons (1 to 16)

Pressing the individual camera buttons will cause the selected camera to display full screen. Buttons are also used to enter passwords.

LED

- **Power LED:** The Power LED is lit when the unit is On.
- **Network LED:** The Network LED is lit when the unit is connected to a network via Ethernet.
- **iSCSI LED:** The iSCSI LED is lit when an iSCSI device is connected to the DVR.
- **HDD LED:** The HDD LED flickers when the DVR is recording or searching video on the hard disk drive.

Jog Dial, Shuttle Ring

- **Jog Dial:** When in the playback mode, you can play video forward image-by-image by turning the Jog Dial clockwise and backward image-by-image by turning the Jog Dial counterclockwise. When in the Setup mode, you can change number values by highlighting the item in the menu and turning Jog Dial clockwise or counterclockwise to increase or decrease the number.
- **Shuttle Ring:** The Shuttle Ring only functions in the Playback mode. The Shuttle Ring is spring loaded and returns to the center position when released. Turning the ring clockwise plays video forward. Turning the ring counterclockwise plays video backward. Playback speed varies with the amount the ring is turned. The playback speeds are ◀◀◀, ▶▶▶, ◀◀◀◀, ▶▶▶▶, ▶x0.5, ▶▶, ▶▶▶ and ▶▶▶▶. When you release the ring, it snaps back to the center position and the video pauses.

Enter Button















The  (Enter) button selects a highlighted item or completes an entry that you have made during system setup.

Arrow Buttons

These buttons are used to navigate through menus and GUI. You can also use them to change numbers by highlighting a number in the menu and using the **Up** and **Down** arrow buttons to increase or decrease the number's value.

These buttons are also used to control Pan and Tilt when in the PTZ mode.

Playback Buttons

- **Backward:** When in the pause mode, pressing the  button moves to the previous image. The button is also used to Zoom Out while in the PTZ mode.
- **Forward:** When in the pause mode, pressing the  button moves to the next image. The button is also used to Zoom In while in the PTZ mode.
- **Rewind:** Pressing the  button plays video backward at high speed. Pressing the button again toggles the playback speed from ,  and . The button is also used for Near Focus in the PTZ mode.
- **Play/Pause:** Pressing the  button plays back video at regular speed. The screen displays  when the DVR is in the Pause mode and the screen displays  when the DVR is playing back video. The button is also used for Far Focus in the PTZ mode.
- **Fast Forward:** Pressing the  button plays video forward at high speed. Pressing the button again toggles the playback speed from ,  and . The button is also used to load a Preset View in the PTZ mode.
- **Search/Stop:** Pressing the  button while in the Live Monitoring mode enters the Search mode. Pressing the  button while in the Search mode returns the DVR to the Live Monitoring mode. The button is also used to save Presets while in the PTZ mode.



PTZ Button

Pressing the  button enters the PTZ (Pan/Tilt/Zoom) mode which allows you to control properly configured cameras.

Alarm Button

The  button has two functions. First, it will reset the DVR's outputs including the internal buzzer during an alarm. Second, it will display the event log when you are in the live monitoring mode unless there is an active alarm.

Panic Button

Pressing the  button starts panic recoding of all camera channels, and displays  on the screen. Pressing the button again will stop panic recording.

Freeze Button

Pressing the  button freezes the current live screen.

Bookmark Button

When in the playback mode, pressing the  button adds the current playback point to the bookmark list or moves to the registered bookmark point.

ZOOM Button

Pressing the **ZOOM** button zooms the current image on the screen. A PIP with a rectangle temporarily displays showing what area of the screen has been enlarged. You can use the arrow buttons to move the rectangle to another area.

NOTE: Entering the zoom mode is NOT supported while in the SD display mode.

Monitor Button

Pressing the **MONITOR** button toggles the monitor selection between Primary (**MONITOR 1** on the remote control), Secondary (**MONITOR 2**) and Spot (**MONITOR 3**). You can select the screen format and sequence monitoring of the selected monitor.

Display Button

Pressing the **DISPLAY** button toggles between different display formats. The available formats are: 2x2, 3x2, 3x3, 4x3 or 4x4 (2x2 or 4x4 on a Spot Monitor). Pressing the button while in 4x4 display format for local cameras enters the display mode for network devices, and pressing the button while in 4x4 display format for network devices enters the display mode for local cameras.

Menu Button

Pressing the **MENU** button enters the **Setup** screen. You will need to enter the authorized user and password to access Setup. Pressing the button also closes the current menu or setup dialog box. In the Playback mode, pressing the button displays the Search menu. In the Search mode clip-copying can be done instantly by pressing and holding the button for three or more seconds.

USB Port

Two USB ports on the front panel are provided to connect external hard disk or flash drives for video clip copying or system upgrades. Position external drives close enough to the DVR so that you can make the cable connections, usually less than 6 feet. Use the USB cable provided with the hard disk drive to connect it to the DVR.

A USB mouse can be connected to one of the ports. You can use the mouse to navigate through the screens and menus much like you would on a computer.

A PostScript™ USB printer (not supplied) can be connected to one of the ports. You can print selected images resulting from a search. *Refer to Chapter 4 — Operation, Searching Video.*

A USB to Serial converter can be connected to the USB port. Multiple text-in devices can be used with a USB to Serial converter.

ID Button on Remote Control

If a DVR System ID is set to 0, the infrared remote control will control that DVR without any additional operations. (Refer to the *System General* setup screen in this chapter for further information on setting the System ID.) If the system ID is 1 to 16, you must press the **ID** button on the remote control and then press the number button (1 to 16) in order to control that DVR. If the System ID of two or more DVRs is set to 0, those DVRs will react to the infrared remote control at the same time.

Sequence Button on Remote Control

Pressing **SEQUENCE** button displays live channels sequentially.

Clip Copy Button on Remote Control





Pressing the **CLIP COPY** button allows you to copy video clips.

Turning on the Power

Connecting the power cord to the DVR turns on the unit. The unit takes approximately 60 seconds to initialize.

Initial Unit Setup

Before using your DVR for the first time, you will want to establish the initial settings. This includes items such as time and date, display language, camera, remote control, record mode, network and password. Your DVR can be set up using various screens and dialog boxes.

Throughout the screens you will see . Highlighting the  and pressing the  button gives you the opportunity to reset that screen to its default settings. After you are finished with any setup screen, you can highlight **Save** and press the  button to save the changes and exit the screen. If you do not wish to save the changes, highlight **Cancel** and press the  button to exit the screen.

Press the **MENU** button or move the mouse pointer on the right edge of the screen and then select  (Login) in the Live Monitoring menu to enter the setup screens. The Login screen appears.



Select a User and enter the password by pressing the appropriate combination of Camera number buttons and then the  button. There is no default password when logging in the **admin** user for the first time.

Figure 5 : Login screen.

NOTE: To assure the secure management of the system, setting up a password is strongly recommended.

If you cannot use the front panel buttons, click the  button using the mouse to enter a password, and the virtual keyboard displays. See instructions below for using the virtual keyboard.

To log the user out of the system, press the **MENU** button or move the mouse pointer to on the right edge of the screen and then select  (Logout) in the Live Monitoring menu. The Logout screen displays asking you to confirm whether or not you want to log out the current user.



Figure 6 : Logout screen.

Setup Screen

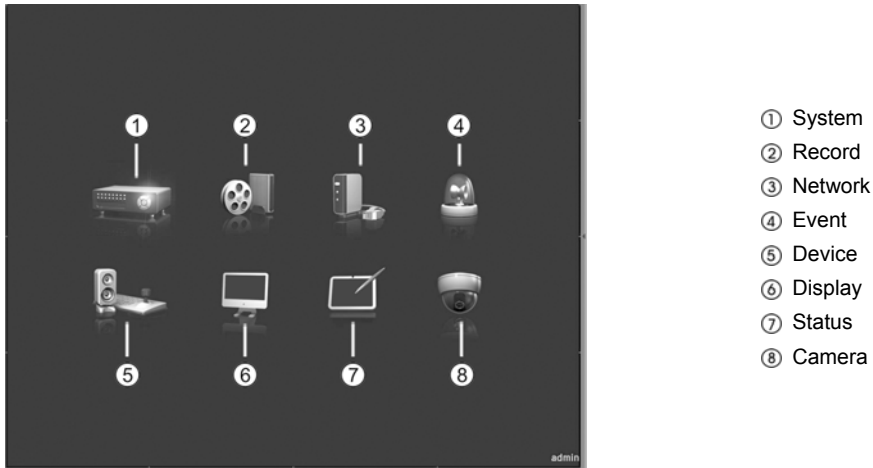

Figure 7 : Setup screen.

Press the **MENU** button or move the mouse pointer to on the right edge of the screen and then select (Setup) in the Live Monitoring menu to enter the setup screen.

While setting up the DVR, there will be many opportunities to enter names and titles. When making these entries, a Virtual Keyboard will appear.



Use the arrow keys to highlight the character you want in the name or title and press the button. That character appears in the title bar and the cursor moves to the next position. Pressing toggles between the upper and lower case keyboards, backspaces, and deletes entered characters.

Special characters can be created using ^ and a capital letter; e.g., ^J for NL (New Line), ^M for CR (Carriage Return). Special characters are commonly used by text input devices and will be useful when performing Text-In Searches.

System Setup

General

Highlight **General** and press the button, and the General screen appears.

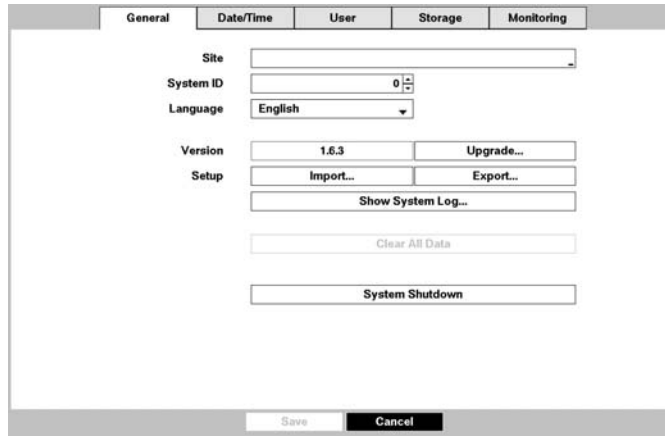

Figure 8 : System – General setup screen.

In the **General** screen, you can name the site location, assign a System ID number, select the language the screens are displayed in, display software version number, upgrade the software, show the System Log, display recorded time data, and clear all data.

Highlight the **Site** box and press the button. A virtual keyboard appears that you can use to enter a Site Name. Once you have entered your title, highlight OK and press the button.

Highlight the box beside **System ID** and press the button. Change the number by highlighting it and using the Up and Down arrow buttons to increase and decrease the number from 0 to 99.

NOTE: The System ID number is used to identify the unit when it is connected with other DVRs through the RS485 port. You cannot use the same ID number for two or more DVRs that are in the same RS485 network. It is possible to have multiple DVRs with System ID 0 that are in the same area as long as they are not part of an RS485 network. If this is the case, all will be controlled at the same time when using the infrared remote control.

Highlight the box beside **Language** and press button. A drop-down menu displays the available languages. Highlight the desired language and press the button.

The box beside **Version** displays the software version of the DVR.

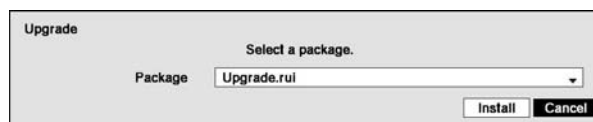



To upgrade the software, connect a USB device containing the upgrade package file to the DVR. Highlight **Upgrade...** and press the button. The **Upgrade** screen appears. The screen displays the upgrade package file names that are available. The “.rui” indicates that the file is for software upgrades and “.off” indicates that the file is for optical drive firmware upgrades.

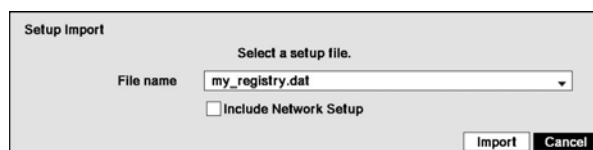

Select the desired file and press the button. Highlighting the **Install** button and pressing the button will install the selected software package. Highlighting the **Cancel** button and pressing the button will close the window without upgrading the software. If the upgrade package file is not installed on the DVR properly, you will get an error message. The system restarts automatically after completing the upgrade.

CAUTION: The USB device must be FAT16 or FAT32 format.

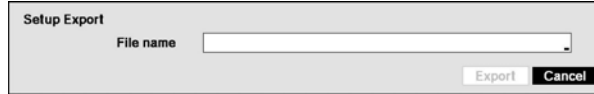

You can import saved DVR settings or export the current DVR settings. To import saved DVR settings, connect the USB device containing the setup file (.dat) to the DVR. Highlight **Setup – Import...** and press the  button. Select the desired setup file and press the **Import** button to import the selected settings and change the DVR settings accordingly. Highlight **Include Network Setup** and press the  button to toggle between On and Off. When set to Off, the network settings will not be changed.



To export the current DVR settings, connect the USB device to the DVR. Highlight **Setup – Export...** and press the  button. Highlight the box beside **File name** and press the  button. A virtual keyboard allows you to enter the file name. Selecting **Export** will save the current settings in .dat file format on the USB device.



NOTE: Even after changing the DVR settings by importing saved settings, the time-related settings (Date/Time, Time Zone and Daylight Saving Time) will NOT be changed.



CAUTION: The USB device must be FAT16 or FAT32 format.

Highlight **Show System Log...** and press the  button to display the System Log.

Time	Type	
01-06-2011 14:07:33	Format Disk : Internal 1	
01-06-2011 14:02:07	Setup Begin	
01-06-2011 14:02:07	Login : admin	
01-06-2011 14:00:58	Boot Up	
01-03-2011 11:59:08	Shutdown	
01-03-2011 11:59:05	Setup End	
01-03-2011 11:59:05	Logout : admin	
01-03-2011 11:55:31	Setup Begin	
01-03-2011 11:55:31	Login : admin	
01-03-2011 11:54:37	Boot Up	
01-03-2011 11:54:14	Shutdown	
01-03-2011 11:54:12	Setup End	
01-03-2011 11:54:12	Logout : admin	
01-03-2011 11:52:11	Setup Begin	
01-03-2011 11:52:11	Login : admin	
01-03-2011 11:49:25	Boot Up	

1 / 9 Export... Close

The System Log screen lists system activities (up to 5,000 from the latest) that have occurred along with the time and date. The  icon will be displayed in the last column for system activities of the remote site. You can scroll through the log pages by using the Up and Down arrows, or you can go directly to a log page by entering the log page number in the box at the bottom left of the screen. Highlight **Close** and press the  button to exit the screen.

To export the system log information, connect the USB device to the DVR. Highlight **Export...** and press the  button. Highlight the box beside **File name** and press the  button. A virtual keyboard allows you to enter the file name. Selecting **Export** will save the log information in .txt file format on the USB device.

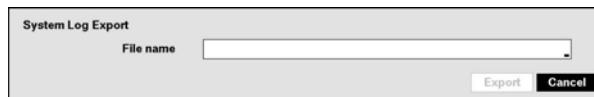

NOTE: When opening the saved .txt file, setting to the proper character encoding and using fixed width fonts will be required to read the file properly.

Highlighting **Clear All Data** and pressing the  button will clear all video data. You will be asked to verify that you wish to clear all data before the DVR erases the video data. **Clear All Data** will not clear the System Log.

Highlighting **System Shutdown** and pressing the  button. The Shutdown screen displays asking you to confirm whether or not you want to shut the system down.



After selecting Shutdown and pressing the  button, a screen will appear telling you when it is safe to disconnect power.

Date/Time

Highlight Date/Time and press the  button, and the Date/Time setup screen appears.

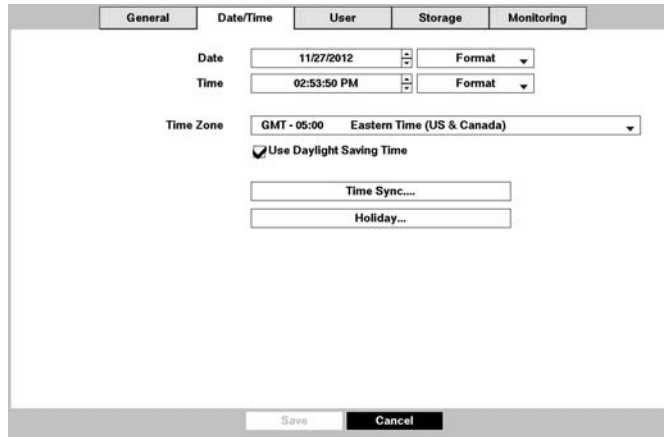











Figure 9 : System – Date/Time setup screen.



Highlight the first box beside **Date** and press the  button. The individual sections of the date will highlight. Use the **Up** and **Down** arrow buttons to change the number. Use the **Left** and **Right** arrow buttons to move between month, date and year. Once you have the correct date, press the  button.



Highlight the Format box beside **Date** and press the  button. Select from the three available date formats and press the  button to save your selected format.

Highlight the first box beside **Time** and press the  button. The individual sections of the time will highlight. Use the **Up** and **Down** arrow buttons to change the number. Use the **Left** and **Right** arrow buttons to move between hour, minutes and seconds. Once you have the correct time, press the  button.

Highlight the Format box beside **Time** and press the  button. Select from the three available time formats and press the  button to save your selected format.

NOTE: The clock will not start running until you have highlighted **Save** and pressed the  button.

Highlight the box beside **Time Zone** and press the  button. Select your time zone from the list and press the  button.

Highlight **Use Daylight Saving Time** and press the  button. Pressing the  button toggles between **On** and **Off**.

Highlighting **Time Sync...** and pressing the  button displays the Time Sync. screen. You can set up time synchronization between the DVR and standard time servers that are available in most time zones and countries, or between the DVR and another DVR.

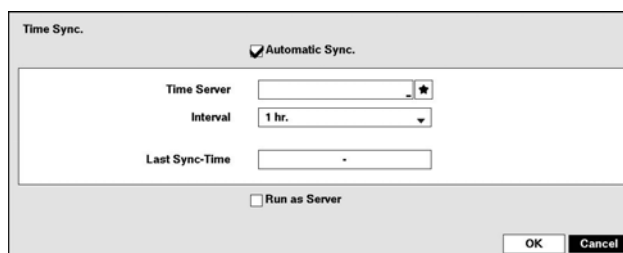



Highlight the box beside Automatic Sync. and press the  button. This toggles between On and Off.

Highlight the box beside Time Server and press the  button. A virtual keyboard appears that you can use to enter the IP address or domain name of the time server. Highlighting  allows you to select your time server from a list of registered time servers.

NOTE: You can use the domain name instead of IP address if you already set up the DNS Server when setting up the Network – IP Address.

Highlight the box beside Interval and press the  button. Set the time interval for synchronization from 30 minutes to 1 day at various time intervals.



Last Sync-Time displays the last time the DVR was synchronized with the time server.

Highlight Run as Server and press the  button. Pressing the  button toggles between On and Off. When it is On, the DVR you are setting up will run as a time server.

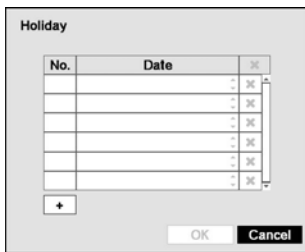
Highlighting Holiday... and pressing the  button displays the Holiday screen.



You can set up holidays by highlighting + and pressing the  button. The current date appears.

Highlight the month and day and change them by using the Up and Down arrow buttons. Press the  button to add the date. Dates can be deleted by highlighting the  beside the date and pressing the  button.

NOTE: Holidays that do not fall on the same date each year should be updated once the current year's holiday has passed.

User



Highlight User and press the  button. The User setup screen displays the authorized groups and users. You can add and delete groups and users. When adding a group, you can assign authority levels to the group.







Figure 10 : System – User setup screen.

The +/- column is used to collapse and expand user groups. If there is a + or – in this column, it indicates the item is a Group Name. If there is a – in front of the Group Name, it indicates that the group has been “expanded” and all of the User Names within that group are displayed below the Group Name. If there is a + in front of the Group Name, it indicates that the group has been “collapsed” and all of the User Names within that group are hidden. To collapse or expand a group, highlight the +/- column in front of the desired group and press the  button.

Highlighting a Group Name and pressing the  button allows you to change the authority levels assigned to the group.



CAUTION: Write down the new password and save it in a secure place. If the password is forgotten, the unit must be reset using the *Factory Reset Button* and all data settings will be lost.

Highlighting a User Name and pressing the  button allows you to add or change the password assigned to that user. You can also change the group to which the user is assigned.

The  column can be used to delete a User Name or an entire Group. If the  is grayed out, that Group or User cannot be deleted. Highlight the  and press the  button. You will be asked to confirm that you want to delete the User or Group. To delete the User currently logged into the DVR on a local system or a PC running ATVision, log the user out of the system first and then delete the user.

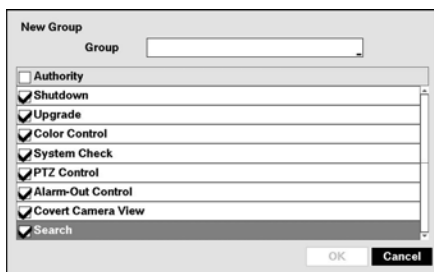
To add a Group, highlight the + Group... box and press the  button. A virtual keyboard appears allowing you to enter the Group name. You can use up to 15 characters including spaces in the group name. Enter the name and assign authority levels to the group.





Highlighting the Authority box and pressing the  button will toggle between all authority levels being turned On and Off. Highlighting the individual authority level boxes and pressing the  button will toggle between that authority level being turned On and Off. The authority levels that can be turned On and Off are:

- Shutdown – The user can shut the system down on a local system.
- Upgrade – The user can upgrade the software on a local system or a PC running ATVision.
- Color Control – The user can control brightness, contrast, hue and saturation for cameras on a local system or a PC running ATVision.
- System Check – The user can view the remote system status or check the remote system status as a batch process on a PC running ATVision.

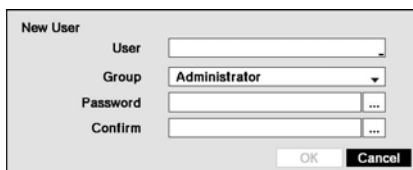
- PTZ Control – The user can control the PTZ camera on a local system or a PC running ATVision.
- Alarm-Out Control – The user can reset the DVR's outputs including the internal buzzer during an alarm by pressing the **ALARM** button on a local system or alarm-out control button on a PC running ATVision.
- Covert Camera View – The user can view video from cameras set as Covert while in the Live Monitoring or Search mode on a local system or a PC running ATVision.
- Search – The user can access the Search mode on a local system or a PC running ATVision.
- Clip-Copy – The user can copy video clips on a local system or a PC running ATVision.
- Setup – The user without Setup authority cannot establish any system settings excluding system shutdown and logout on a local system or a PC running ATVision.
- System Time Change – The user can change the system date and time on a local system or a PC running ATVision.
- Data Clear – The user can clear all video data or format disks on a local system or a PC running ATVision.
- PTZ Setup – The user can establish all PTZ settings on a local system or a PC running ATVision.
- Alarm-Out Setup – The user can establish all Alarm-Out settings on a local system or a PC running ATVision.
- Covert Camera Setup – The user can establish all Covert Camera settings on a local system or a PC running or a PC running ATVision.
- Record Setup – The user can establish all Record settings on a local system or a PC running ATVision.
- Setup Import – The user can import saved DVR settings from a local system or a PC running ATVision.
- Setup Export – The user can export the current DVR settings to a local system or a PC running ATVision.
- VNC Setup – The user can establish all VNC settings on a local system or a PC running ATVision.



To add a User, highlight the + User... box and press the  button. A virtual keyboard appears allowing you to enter the User Name. Enter the name and assign the User to a Group and password. You can use camera buttons on the front panel to assign the password. The password can be up to 8 digits. You will be asked to confirm the password.

NOTE: In addition to using the front panel buttons or the infrared remote control, you can use the virtual keyboard to assign the password. To display the virtual keyboard click the  button using the mouse.

Highlighting the box beside Auto Login allows you to select a User to be automatically logged in when the DVR is powered up. It can also be set to never automatically login a user.

Highlighting the box beside Auto Logout allows you to select from a list of times that the user will be automatically logged out. The options are: Never, 1 min., 3 min., 5 min., 10 min., 15 min., 20 min., 30 min. and 1 hr.

Storage

Highlight Storage and press the  button. The Storage setup screen appears and displays information about the DVR's storage devices.

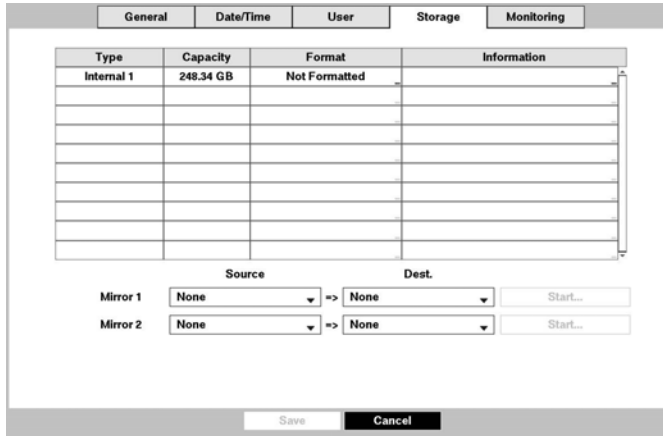

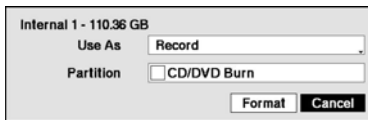



Figure 11 : System – Storage setup screen.

The information in the Type column describes the storage device.

The capacity of the storage device is displayed in the Capacity column.

The Format column displays whether the device is used for recording (Record), archiving (Archive) or not (Not Using). Not formatted indicates the device is not formatted.  indicates when the device has temporary space set aside so that video clips can be saved on a DVD RW.



Highlight the box in the Format column for the desired storage device and press the  button. You will be able to format the device for recording or archiving. When selecting Not Using from Use As and highlighting the Format button, the device will not be used for either recording or archiving. You can also set aside space to store temporary files for CD or DVD burning by selecting Partition – CD/DVD Burn.

NOTE: The DVR does NOT support USB hard disk drives with a version lower than 2.0.

iSCSI devices cannot be formatted and used for archiving.



iSCSI and eSATA devices cannot be partitioned for CD or DVD burning.

The Information column displays whether the device is being used or not. Other indicates the device has been used for another DVR.

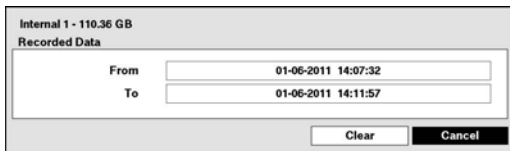
Highlight the box in the Information column for the desired storage device and press the  button. You will be able to check the time information about recorded data.



If you want to erase recorded data on the selected device, highlight Clear and press the  button. You will be asked whether or not you want to delete the data.

If you want to use a USB hard disk drive, highlight Use and press the  button after connecting the device. Highlight Don't Use and press the  button if you want to stop using the device.

CAUTION: Do NOT disconnect the USB cable or the power from the device while copying video clips. If the USB cable is disconnected while copying video clips, archived data might be lost.

Highlight the boxes beside **Mirror** and press the **←** button. The DVR can be set up to mirror **Source** disks to designated **Dest.** (destination) disks selected from internal hard disk drives. Refer to the *Chapter 4 – Disk Mirroring* for further information on setting up disk mirroring.

Monitoring

Highlight **Monitoring** and press the **←** button, and the Monitoring setup screen appears.

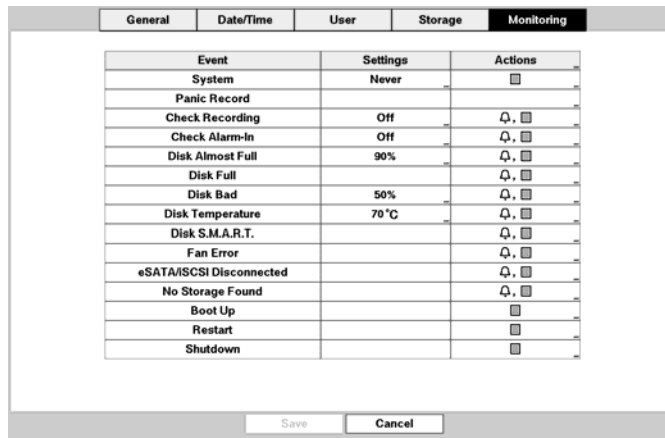

Figure 12 : System – Monitoring setup screen.

The DVR can be configured to run self-diagnostics and report the results.

Highlight the **Settings** box beside the desired event (**System**, **Check Recording**, **Check Alarm-In**, **Disk Almost Full**, **Disk Bad**, or **Disk Temperature**), and press the **←** button.

Highlight the **Settings** box beside **System** and press the **←** button. You can select the interval that you want the DVR to run self-diagnostics on the system. You can select from 1 hr. to 30 days or **Never**.

Highlight the **Settings** box beside **Check Recording** and press the **←** button. The Check Recording screen appears.

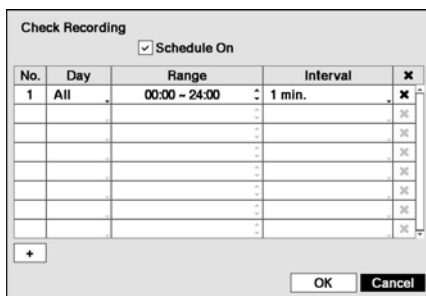

Highlighting **Schedule On** and pressing the **←** button toggles **On** and **Off**. When set to **On**, you can select the day, time range and interval that you want the DVR to run self-diagnostics on the recorder. The **Interval** can be selectable from 1 min. to 7 days or **Never**. Highlight the **+** and press the **←** button to add a schedule item. The **X** box allows you to delete a check recording schedule.

Highlight the **Settings** box beside **Check Alarm-In** and press the **←** button. You can select the interval that you want the DVR to run self-diagnostics on Alarm Inputs. You can select from 1 hr. to 30 days or **Never**.

Highlight the **Settings** box beside **Disk Almost Full**, and press the **←** button. Select the percentage level of disk usage at which you want the DVR to trigger an alert. Percentage levels range from 80% to 99%.

Highlight the **Settings** box beside **Disk Bad**, and press the **←** button. Select percentage level of bad disk sectors at which you want the DVR to trigger an alert. Percentage levels range from 10% to 90%.

Highlight the **Settings** box beside **Disk Temperature**, and press the **←** button. Select the temperature of hard disk drive at which you want the DVR to trigger an alert if the temperature exceeds the defined threshold. Refer to the hard disk drive manufacturer's documentation for the correct temperature setting.

The DVR can be set to react to system events. Highlight the **ACTIONS** box beside the desired event and press the **↵** button. System events can be associated with an Alarm-Out connector, sound the DVR's internal buzzer, and/or notify a number of different devices.

NOTE: *Alarm-Out* action cannot be set to *System* and *Panic Record* events.

For the *Notify* action to work, the DVR should be registered in the ATVision (Remote Administration System).

Recording Setup

General

Highlight **General** and press the **↵** button, and the General setup screen appears.



Figure 13 : Record – General setup screen.

Highlighting **Recycle** and pressing the **↵** button toggles between On and Off. In the Recycle mode, the DVR records over the oldest video data once all available storage space has been used. When Recycle is turned off, the DVR stops recording once all available storage space has been used.

Highlighting **Use De-Interlace** and pressing the **↵** button toggles between On and Off. When set to On, the DVR will turn the de-interlace filter on while recording video with Very High (D1) resolution.

NOTE: The video signal has a time difference of 1/60 second (1/50 second for PAL) between odd and even fields because it is composed of 60 interlaced fields per second (50 fields for PAL). When recording video with Very High (D1) resolution, video is made up of frame units combining two fields – one odd field and one even field. This can cause horizontal scan lines or flashes in areas with motion because of the time difference between the two fields. Turning on the de-interlace filter provides clearer video by eliminating these horizontal scan lines and flashes.

Highlight the **Event Record Dwell** box and set the length of time you would like to record for the associated event. You can set the dwell from 5 seconds to 15 minutes. Refer to *Event Actions* screen in this chapter for information regarding event recording.

Highlight the slide bar beside **Auto Deletion**, and use the Left and Right arrow buttons or Up and Down arrow buttons to adjust the length of time recorded data will be kept from 1 to 999 days. The DVR automatically deletes video recorded earlier than the user-defined period under three conditions: at midnight, whenever the system reboots or whenever the user changes the Auto Deletion settings. Selecting **Never** will disable the Auto Deletion function.

Highlight the slide bar beside Limit Time-Lapse Recording, and use the Left and Right arrow buttons to adjust the length of the maximum storage time for time-lapse recording from 1 to 99 days. The Limit Time-Lapse Recording feature will function when the storage device has enough space to record video data longer than the preset period. When this feature is On, the DVR records over the oldest “time-lapse” video once all available storage has been used in the Recycle mode, so more event video can be saved. Selecting Never will disable the Limit Time-Lapse Recording function.

NOTE: When the storage device does not have enough space to record video data longer than the preset Limit Time-Lapse Recording period, the DVR records over the oldest video data (time-lapse or event video) as it would in the Recycle mode even if this feature is turned On.

The maximum storage time is only an estimate because the amount of space required to store video varies depending on many factors such as motion and image complexity.

CAUTION: When more than one disk is installed in the unit, the DVR records video on the disks sequentially based on time. And these sequentially recorded videos have the advantage that you can search recorded video easily even though a disk is removed from the unit. However, video recorded in the same time range might be saved on different disks by channel and by the type of recording mode. Once the Limit Time-Lapse Recording is set to On, the DVR will maintain this recording limitation even after disabling the function. If you want the DVR to record video on the disks sequentially based on time again, you must format all disks that are currently used for recording.

Highlighting Use Panic Recording and pressing the  button toggles between On and Off.

Highlight the Panic Recording – Duration box and set the duration of panic recording. Panic recording will stop automatically after the preset duration as long as the **PANIC** button is not pressed to stop the panic recording. You can set the dwell from 5 minutes to 1 hour. Select No Limit if you want to stop panic recording manually.

Highlighting the Panic Recording – ips and pressing the  button allows you to set the images per second for Panic recording. You can select from 1.00 to 30.00 ips (25.00 ips PAL).

Highlighting the Panic Recording – Quality and pressing the  button allows you to set the recorded image quality for Panic recording. You can select from: Very High, High, Standard and Basic.

Highlighting the Panic Recording – Resolution and pressing the  button allows you to set the recorded image resolution for Panic recording. You can select from: Very High (D1), High (Half D1) and Standard (CIF).

Schedule

Highlight Schedule and press the  button, and the Schedule setup screen appears.

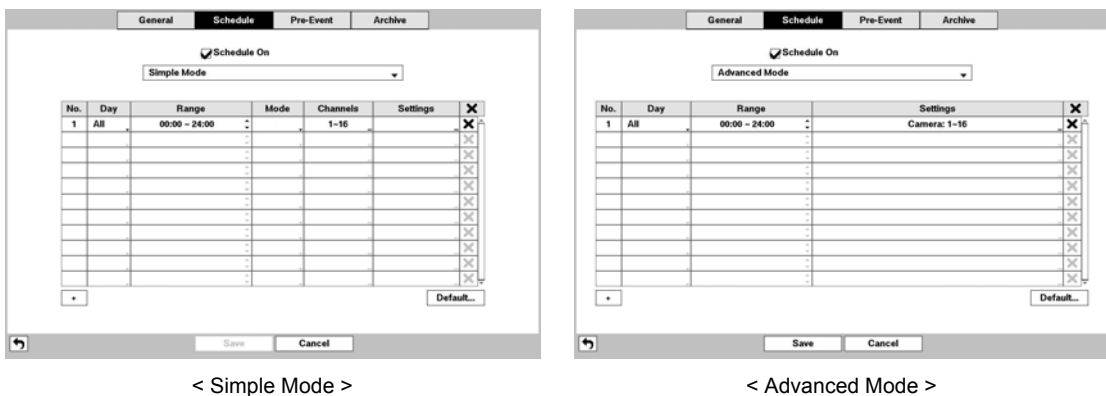





Figure 14 : Record – Schedule setup screen.

You can program the DVR to record only during certain times based on time, day of the week, and holidays. The smallest time segment you can use is 15 minutes.

Highlighting Schedule On and pressing the  button toggles between On and Off. In the Schedule On mode, the DVR records video based on the schedule established in the Schedule screen. When turning Schedule recording Off, you will be asked to confirm your decision, and  displays at the top-left corner of each camera screen. Panic recording will function even when Schedule is turned off.  displays during panic recording.

Highlight the Schedule Mode box and press the  button. You can select between Simple Mode and Advanced Mode. Selecting Advanced Mode allows you to set up individual recording schedule for each event.

NOTE: Changing the schedule mode will reset all event and action statuses.



Highlight the + and press the  button to add a schedule item.





Highlight the box under the Day heading and press the  button to change the days that the scheduled recording will take place. Choose from: Sun, Mon, Tue, Wed, Thu, Fri, Sat, M-F, Hol and All.



Highlight the box under the Range heading and press the  button to change the time range that the scheduled recording will take place. The smallest time segment you can use is 15 minutes.

Highlight the box under the Mode heading and press the  button to change the recording mode that will be used. Choose from: No Record, Time, Event and Time & Event. (Simple Mode Only)

When the DVR is in the No Record mode, it will not record during the preset day and time range as long as the **PANIC** button is not pressed. Use the No Record mode when you do NOT want the DVR to record during certain times.

When the DVR is in the Time mode, the  icon displays at the top-left corner of the screen. The DVR will record and displays the  icon at the top-left corner of the screen during the scheduled times.

When the DVR is in the Event mode, the red  icon displays at the top-left corner of the screen. The DVR will record and displays the  icon at the top-left corner of the screen when any event occurs. When the DVR is in the Pre-Event recording mode, the yellow  icon displays when there is no event, and the DVR is not recording. When the DVR is in the Pre-Event mode, the red  and  display when any event occurs and the DVR starts recording.

When the DVR is in the Time & Event mode, the DVR will follow the Time settings and the  icon displays at the top-left corner of the screen. The DVR follows the Event settings and the  icon displays.

Highlight the box under the Channels heading and press the  button to select which cameras will be recorded. (Simple Mode Only)

Highlight the box under the Settings heading and press the  button to define the recording settings.

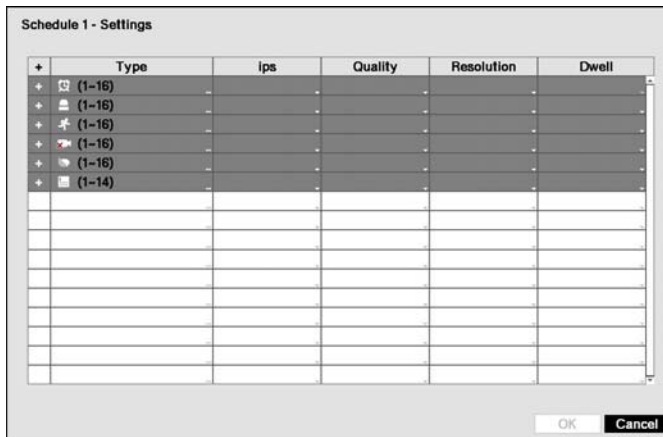

Figure 15 : Schedule – Settings (Advanced Mode) setup screen.

You can set the ips, Quality and Resolution (ips, Quality, Resolution and Dwell for Advanced Mode setup) of the recording for any modes you set up in the Mode column. If you do not set the ips, Quality, Resolution and Dwell in the Settings column, the DVR will follow the default settings. See below for details.

NOTE: The recording speed (ips), quality and resolution used by the network camera are the settings you set in the camera not those set in the DVR.

Descriptions of the Record icons in the *Type* column are as follows:

- | | | | |
|--|--|--|--|
|  Time-lapse (Time) |  Alarm-In |  Motion |  Video Loss |
|  Video Blind |  Audio (Network Devices Only) |  Trip-Zone (Network Devices Only) | |
|  Tampering (Network Devices Only) |  Text-In | | |

Channels that are not defined will use the setting values of the previous schedule item.

When multiple events are detected at the same time from a specific channel, the DVR will record event video with the high setting values if the ips, Quality, Resolution and Dwell values of events are different from each other. However, the ips will be reset to the supported maximum value when the ips, Quality, Resolution and Dwell are all set to the highest value. (Advanced Mode Only).

When the ips, quality and resolution for the network video transmitter you set in the DVR are higher than those you set in the network video transmitter, the DVR will record video using the settings in the network video transmitter.

Depending on network conditions, the ips, quality and resolution for the network video transmitter (ips for the network camera) may not be attainable.

For network devices using the ONVIF™ Conformance Protocol, the DVR records using the profile settings designated in the DVR preset profiles. You can designate which profile to use for recording when setting up the network device. Refer to *Camera – Network Camera* setup screen in this chapter and *Appendix – Remote Setup of Network Devices* for further information on setting up the network device.

CAUTION: When network devices are connected, recording speed might decrease and system performance might be affected if the recording speed (ips) is set to the highest value.

Highlight the box under the **X** heading and press the  button to delete the recording settings. You will be asked to confirm that you want to delete the settings.

Highlight Default... and press the  button. The Default screen appears.

Default				
Mode	ips	Quality	Resolution	Dwell
Time	30.00 ips	High	High	
Event	30.00 ips	Very High	Very High	5 sec.

 OK Cancel

Highlighting boxes under ips and pressing the  button allows you to set the images per second for Time and Event recording. You can select from 1.00 to 30.00 ips (25.00 ips PAL).

Highlighting boxes under Quality and pressing the  button allows you to set the recorded image quality for Time and Event recording. You can select from: Very High, High, Standard and Basic.

Highlighting boxes under Resolution and pressing the  button allows you to set the recorded image resolution for Time and Event recording. You can select from: Very High (D1), High (Half D1) and Standard (CIF).

Highlighting boxes under Dwell and pressing the  button allows you to set the length of time you would like to record for the associated event. (Advanced Mode Only)

Pre-Event

Highlight Pre-Event and press the  button, and the Pre-Event setup screen appears. If you do not have Event set up in the Record Schedule, a message will display alerting you to this fact.

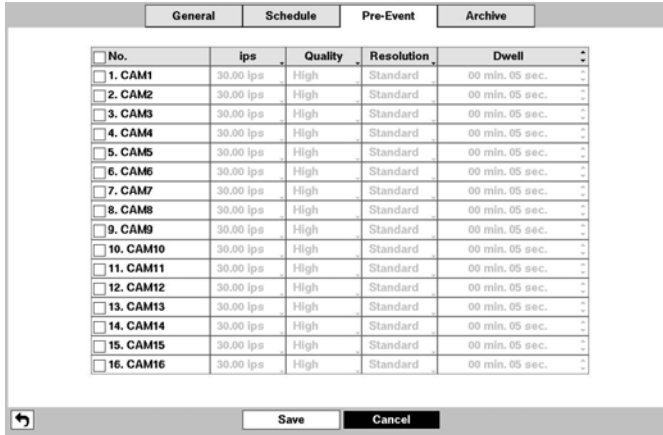

Figure 16 : Record – Pre-Event setup screen.

When the DVR is in the Event Record mode it is possible to have it record images before the event occurs. The Pre-Event screen allows you to define how to handle pre-event recording.

You can turn individual cameras On or Off for pre-event recording. The image speed can be set from 1.00 to 30.00 ips (25.00 ips PAL), image quality can be selectable from Very High, High, Standard and Basic, and image resolution can be selectable from Very High (D1), High (Half D1) and Standard (CIF).

NOTE: Depending on network conditions, the ips, quality and resolution for the network video transmitter (ips for the network camera) you set may not be attainable.

You can set the amount of time to record prior to the event by adjusting the Dwell. You can set the Dwell from 5 seconds to 30 minutes. The longer the dwell set, the fewer maximum ips can be set.

NOTE: Depending on the ips, quality and resolution of recorded video, the pre-event Dwell you set may not be attainable. (Network Camera Only)

When the DVR is in the Time or Time & Event mode, it ignores the pre-event settings and follows the time settings.

Archive

Highlight Archive and press the button, and the Archive setup screen appears.

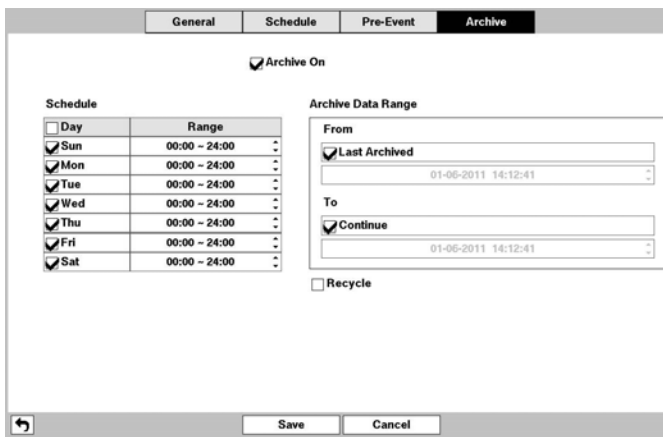

Figure 17 : Record – Archive setup screen.

Highlight Archive On and press the button to toggle between On and Off.

NOTE: If you have not set up a storage device for archiving, a message appears notifying you of this.

Select the Days and Time Range you want archived.

You can accept the Archive Data Range by leaving the default checkmarks in the Last Archived and Continue boxes. If you wish to enter specific times and dates in From and To, toggle the checkmarks Off and then enter the time and date.

Highlight Recycle and press the button to toggle between On and Off. When Recycle is On and the storage device is full, the newest archived video data will overwrite the oldest archived data. When Recycle is Off, the DVR will stop archiving video data until more space is made available.

CAUTION: When the Recycle is On, changing the start date and time for archiving will delete all archived data after the changed start date and time.

Network Setup

General

Highlight General and press the button, and the General setup screen displays.

Figure 18 : Network – General setup screen.

You can limit the network bandwidth settings so that system does not consume too much network bandwidth. Highlight the box beside Network Bandwidth Limit and press the Up and Down arrow buttons to set the desired maximum bandwidth from 50Kbps to 1Gbps.

NOTE: When limiting the network bandwidth, the remote watch image on the PC running ATVision might not be displayed properly.

The DVR supports two-way audio communication between a local system and a PC running ATVision. Highlighting the box beside Remote Audio Channel and pressing the button allows you to select the audio channel that sends audio to the remote site. Selecting Select From ATVision will send audio of the channel selected from ATVision.

NOTE: Depending on network conditions, audio might be interrupted or out of synchronization during transmission.



Highlight Use SSL for Transferring Data and press the button to toggle between On and Off. When it is On, the security of data except video and audio transmitted for remote monitoring or remote recording can be enhanced by using the SSL (Secure Sockets Layer) authentication. When using the SSL function, the DVR cannot be connected with a remote program or a network keyboard which does not support the SSL function.



CAUTION: The remote connection will be disconnected temporarily after changing the SSL settings.

NOTE: This product includes software developed by the OpenSSL Project for use in the OpenSSL Toolkit (<http://www.openssl.org>).

Highlight the first box beside Remote Watch – bps/ips. Press the Up and Down arrow buttons to set the Transfer Speed from 50Kbps to 1Gbps.

Highlight the second box beside Remote Watch – bps/ips. You can select the unit of measure for the transfer speed between: bps and ips. Press the  button to set the transfer speed.

Highlight the box beside Remote Watch – Quality and press the  button. You can select the Quality from: Very High, High, Standard and Basic. Press the  button to set the Quality.

Highlight the box beside Remote Watch – Resolution and press the  button. You can select the Resolution from: High (Half D1) and Standard (CIF). Press the  button to set the Resolution.

NOTE: The higher Quality and Resolution settings require higher Transfer Speed settings. The transfer speed you set is the maximum speed. Depending on the network environment, this speed may not be achieved.

Highlight ATVision – Use ATVision Service and press the  button to toggle between On and Off. See *Appendix – ATVision* for detailed descriptions of the ATVision service.

Highlight the box beside ATVision – Port and press the  button. Set the port number used when accessing ATVision by using the Up and Down arrow buttons to increase or decrease the numbers.

Highlight Use VNC (Virtual Network Computing) and press the  button to toggle between On and Off. You will be able to change the settings if Use VNC is enabled.



NOTE: VNC service allows you to access the DVR and control it remotely using a PC or mobile devices via Ethernet.

Highlight the box beside Port and press the  button. Set the port number of the VNC server obtained from your system administrator.

Highlight the box beside Password and press the  button. A virtual keyboard appears allowing you to enter the password for VNC connection.

NOTE: Up to three users at a time can access a DVR remotely via VNC service.

When controlling the DVR remotely using a keyboard, shortcut keys perform the following functions as described below:

Key	Function
“←” or “h”	Pressing the “←” or “h” key moves to the left in the menu. It is the same as pressing the Left arrow button on the front panel.
“→” or “l”	Pressing the “→” or “l” key moves to the right in the menu. It is the same as pressing the Right arrow buttons on the front panel.
“↑” or “k”	Pressing the “↑” or “k” key moves up in the menu. It is the same as pressing the Up arrow button on the front panel.
“↓” or “j”	Pressing the “↓” or “j” key moves down in the menu. It is the same as pressing the Down arrow button on the front panel.
“m” or  (Windows)	Pressing the “m” or  key displays the Live Monitoring menu or Search menu on the screen. It is the same as pressing the MENU button on the front panel.
“Enter” or “Return”	Pressing the “Enter” or “Return” key selects the highlighted item or completes an entry that you have made during system setup. It is the same as pressing the  (Enter) button on the front panel.
“d” or “PageUp” or “PageDown”	Pressing the “d” or “PageUp” or “PageDown” key toggles between different display formats. It is the same as pressing the DISPLAY button on the front panel.
“c” or “Home”	Pressing the “c” or “Home” key allows you to copy video clips. While in the playback mode, it is the same as pressing and holding the MENU button on the front panel for three or more seconds.
“F5”	Pressing the “F5” key refreshes the current VNC screen.

IP Address

Highlight IP Address and press the , and the IP Address setup screen displays.





Figure 19 : Network – IP Address (Manual) setup screen.

Highlight the box beside Type and press the . You can select the type of network configuration from: Manual, DHCP and ADSL (with PPPoE). Select the desired type and press the .

Selecting Manual from the Type allows you to set up LAN parameters manually.

Change the numbers by highlighting them and using the Up and Down arrow buttons to increase or decrease the number. The factory default LAN settings are:

IP Address: 192.168.1.129
 Gateway: 192.168.1.254
 Subnet Mask: 255.255.255.0

NOTE: You will need to get the appropriate IP Address, Gateway and Subnet Mask from your network administrator.

Highlight the box beside DNS Server. Press the Up and Down arrow buttons to set the IP address of the DNS server.

Highlight the Port Number Setup... box and press the . The Port Number Setup screen appears.

NOTE: You will need to get the appropriate Port Numbers for each ATVision related program (Admin, Callback, Watch and Search) from your network administrator.

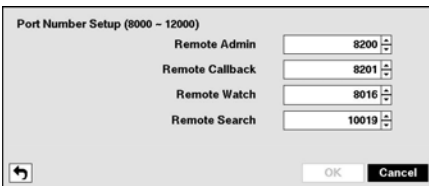

Change the numbers by highlighting them and using the Up and Down arrow buttons to increase or decrease the number. The factory default Port settings are:

Remote Admin: 8200
 Remote Callback: 8201
 Remote Watch: 8016
 Remote Search: 10019

NOTE: The system restarts automatically after changing the port settings.

Do NOT use the same port number for two different programs, otherwise, the DVR cannot be connected with the PC running ATVision.

CAUTION: When changing the port settings, you must change the port settings on the PC running ATVision as well. Refer to the ATVision manual for details.

Highlight Use UPnP and press the  button to toggle between On and Off. When it is On, port forwarding from the NAT (Network Address Translation) device to the DVR will be enabled automatically via UPnP (Universal Plug and Play) service. This function will be especially useful when accessing a port on a private IP address.

NOTE: For the UPnP service to work, the NAT device should support the UPnP Port Forwarding function and the function should be set to enabled.

You cannot change the port settings when Use UPnP is On.

Highlight the Status box and press the  button to display the port numbers forwarded from the NAT device via UPnP service.





Selecting DHCP from the Type and highlighting Save button reads the current IP address of the DVR configured by DHCP (Dynamic Host Configuration Protocol) network.

Highlight Auto (Default) and press the  button to toggle between On and Off. When it is On, the DVR will obtain the IP address of the DNS server automatically.

NOTE: Selecting Auto will only be enabled when the DVR is configured for DHCP or an ADSL network.

Selecting ADSL (with PPPoE) allows you to set up the ADSL network.

Highlight the box beside ID and press the  button. A virtual keyboard appears allowing you to enter the ID for ADSL connection.

Highlight the box beside Password and press the  button. A virtual keyboard appears allowing you to enter the password for ADSL connection.

NOTE: Entering the ID and Password and highlighting OK reads the current IP address of the DVR configured by the ADSL network.

If the DVR is configured for DHCP or an ADSL network, the IP address of the DVR might change whenever the unit is turned on.

DVRNS

Highlight DVRNS and press the  button, and the DVRNS setup screen displays.

Figure 20 : Network – DVRNS setup screen.

Highlight Use DVR Name Service and press the button to toggle between On and Off.

NOTE: The DVRNS (DVR Name Service) allows the DVR to use Dynamic IP addresses for remote connection. When this feature is On, you can access your DVR remotely using the DVR name instead of its IP address. For the DVRNS feature, the DVR should be registered on the DVRNS server.

Highlight the box beside DVRNS Server and press the button. A virtual keyboard appears allowing you to enter the IP address or domain name of the DVRNS server.

NOTE: You will need to get the IP Address or domain name of the DVRNS Server from your network administrator. You can use the domain name instead of IP address if you already set up the DNS Server when setting up the Network – IP Address.

Highlight the box beside Port and press the button. Set the port number of the DVRNS server using the Up and Down arrow buttons to increase or decrease the numbers.

Highlight Use NAT and press the button to toggle between On and Off.

NOTE: When using the NAT (Network Address Translation) device, refer to the NAT manufacturer's instructions for the proper network settings.

Highlight the box beside DVR Name and press the button. A virtual keyboard appears allowing you to enter the DVR name to be registered on the DVRNS server.

Highlight the Check box and press the button to check whether or not the name you entered can be used.

NOTE: The DVR name you entered should be checked by selecting Check, otherwise the DVRNS changes will not be saved.

When entering no name or a name already registered on the DVRNS server, an error message displays.

Highlighting Save and pressing the button registers the DVR on the DVRNS server. Proper DVRNS settings will display the help desk information of the DVRNS server in the box beside Help Desk.

RTSP

Highlight RTSP and press the  button. The RTSP setup screen displays.

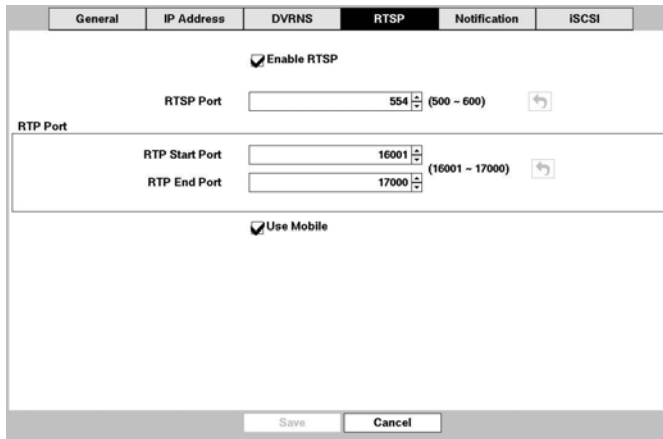







Figure 21 : Network – RTSP setup screen.

Highlight **Enable RTSP** (Real-Time Streaming Protocol) and press the  button to toggle between On and Off. You will be able to change the settings if Enable RTSP is enabled.

Highlight the box beside **RTSP Port** and press the  button. Set the port number of the RTSP server obtained from your system administrator.

Highlight the box beside **RTP Start Port** and press the  button. Set the start port number of the RTP server obtained from your system administrator.

Highlight the box beside **RTP End Port** and press the  button. Set the end port number of the RTP server obtained from your system administrator.

Highlight **Use Mobile** and press the  button to toggle between On and Off. When set to on, you can access a remote DVR using a Blackberry or other mobile devices.

NOTE: Selecting *Use Mobile* sets the ATVision service to be enabled automatically regardless of your ATVision settings.

When using NAT (Network Address Translation) or firewall services, opening all UDP ports allows you to access a DVR using Blackberry and Android devices.

You can access a remote DVR and monitor live video images using media players, such as VLC Player, supporting RTSP service. Start the media player on your local PC and enter "rtsp://ID:Password@IP address:RTSP port number/track ID='channel number'", or start Internet Explorer on your Blackberry or other mobile devices and enter "http://IP address:ATVision port number".

Some media players might play video properly depending on network conditions.

RTSP service might not be supported, depending on the type of media player.

Notification

Highlight Notification and press the  button. The Notification setup screen displays.

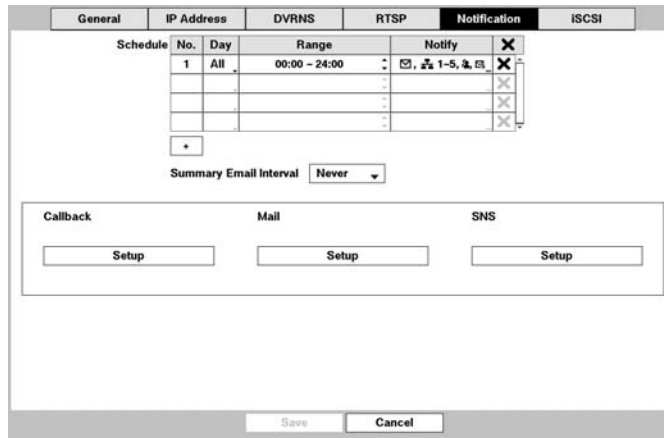





Figure 22 : Network – Notification setup screen.



You can add and edit notification schedules. Highlight the + and press the  button to add a schedule. Highlighting the boxes under the Column heading and pressing the  button allows you to edit the information in those boxes.

The Day box allows you to select the days that the notification schedule will be active. The choices are: Sun, Mon, Tue, Wed, Thu, Fri, Sat, M~F, Hol and All.

The Range box allows you to set the time that the notification schedule will be active in 15-minute increments from 00:00 to 24:00.

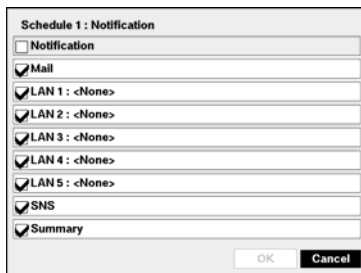
Highlight the desired box under the Notify heading, and press the  button. The Schedule Notify menu appears.





You can toggle the entire list On and Off by highlighting Notification and pressing the  button. You can toggle the individual items On and Off by highlighting that item and pressing the  button. Highlight OK and press the  button to accept your changes.

NOTE: For the Notify action, the notify item you select should be enabled in the Notification setup screen and the DVR should be registered in the ATVision (Remote Administration System).

Highlight the box beside Summary Email Interval and select the interval that you want the DVR to send a summary email. The DVR will send an email containing a summary of events detected during the preset interval.

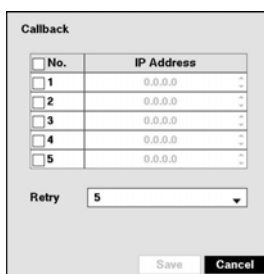
Highlight Callback – Setup and press the  button, and the Callback screen appears. The DVR can be set up to contact a computer running ATVision (Remote Administration System) when an event occurs.





Highlight the box under the No. heading and press the  button to toggle between On and Off. You will only be able to change the IP addresses if No. is enabled.

Highlight the IP Address box that you want to change and press the  button. Use the arrow buttons to enter the IP address of the computer you want contacted during an event. You can enter up to five IP addresses.

Highlight the box beside Retry and enter the number of times you would like the DVR to try contacting the computer. You can select from 1 to 10 retries.

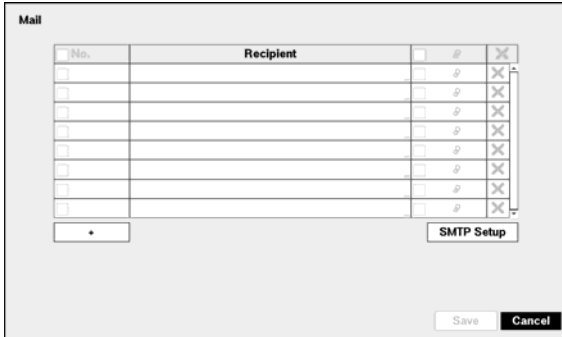
Highlight Mail – Setup and press the  button, and the Mail screen appears. The DVR can be set up to send an email when an event occurs.



The Mail account can be turned On or Off by highlighting the boxes under the NO. heading and pressing the  button.

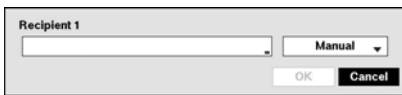

Highlight the + and press the  button to add a mail recipient.





Highlight the first box under Recipient and press the  button. A virtual keyboard appears that you can use to enter the recipient's e-mail address.

Highlight the second box under Recipient and press the  button. You can select between Manual and listed SMTP mail server providers.

NOTE: The e-mail address must include the “@” character to be a valid address.

Highlight the box under the  heading and press the  button to toggle between On and Off. The DVR will clip an event detected video segment and attach it to an email when the  box is turned On.

NOTE: Attaching a video clip to an email will not be available for the Text-In event.

The Mail accounts can be deleted by highlighting the  beside the account and pressing the  button.

Highlight SMTP Setup and press the  button. The SMTP Setup screen appears.

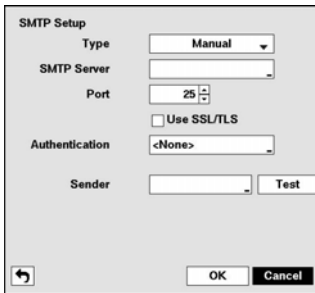



Highlight the box beside Type and press the  button. You can select between Manual and listed SMTP mail server providers.

Highlight the box beside SMTP Server and press the  button. A virtual keyboard appears that you can use to enter the IP address or domain name of the SMTP server.



NOTE: You will need to get the IP Address or domain name of the SMTP Server from your network administrator.

You can use the domain name instead of IP address if you already set up the DNS Server when setting up the Network – IP Address.

Highlight the box beside PORT and press the  button. Use the arrow buttons to enter the SMTP Server port number obtained from your system administrator. The default port number is 25.

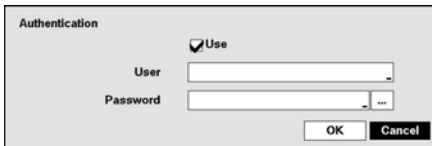
Highlight Use SSL/TLS and press the  button to toggle between On and Off. When it is On, the DVR can send an email via an SMTP server requiring SSL (Secure Sockets Layer) authentication.



Highlight the box beside Authentication and press the  button. An Authentication screen appears. Highlight Use and press the  button to toggle between On and Off. Highlight the box beside User/Password and press the  button. A virtual keyboard appears allowing you to enter the user ID and password.

NOTE: In addition to using the front panel buttons or the infrared remote control, you can use the virtual keyboard to assign the password. To display the virtual keyboard click the  button using the mouse.

This product includes software developed by the OpenSSL Project for use in the OpenSSL Toolkit (<http://www.openssl.org>).

Highlight the box beside **Sender** and enter the sender's e-mail address. Use the virtual keyboard to enter the e-mail address.

NOTE: The e-mail address must include the "@" character to be a valid address.

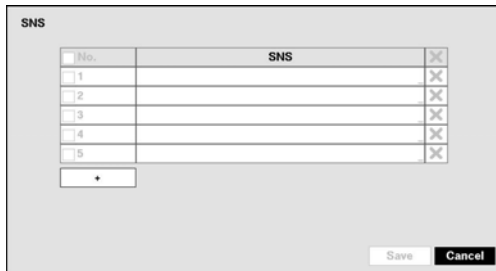

Highlight the **Test** box and press the  button to test emailing with the current settings you made.

Highlight **SNS – Setup** and press the  button, and the SNS screen appears. The DVR can be set up to post a message via SNS (Social Network Service) when an event occurs.



You can add and edit the SNS account on this screen. The SNS account can be turned On or Off by highlighting the boxes under the **NO.** heading and pressing the  button.



To add an SNS account, highlight the **+** and press the  button. Highlight the box beside **Type** and press the  button. Selecting **TWITTER** from the **Type** allows you to post a tweet on Twitter when an event occurs.

Highlight the box beside **User Name/Password** and press the  button. A virtual keyboard appears allowing you to enter the user name and password.

The SNS accounts can be deleted by highlighting the **X** beside the account and pressing the  button.

NOTE: Posting a tweet might fail because of Twitter limitations.

iSCSI

Highlight **iSCSI** and press the  button. The iSCSI setup screen displays.

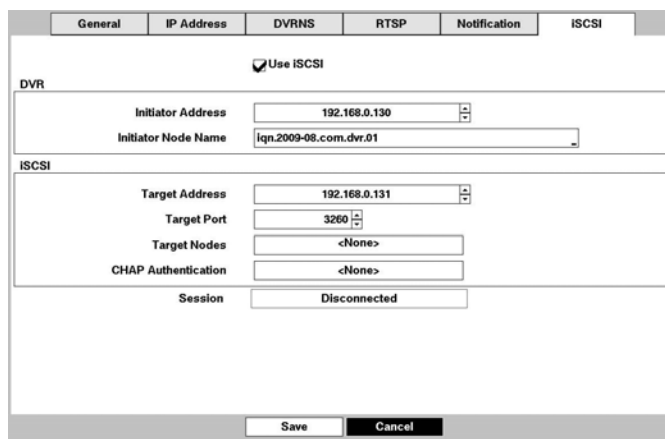



Figure 23 : Network – iSCSI setup screen.

Highlight **Use iSCSI** and press the  button to toggle between On and Off.

Highlight the **DVR – Initiator Address** box and press the  button. Use the arrow buttons to enter the IP address of DVR.

NOTE: You will need to get the IP address from your network administrator.

Do NOT use the same IP address for the *Initiator Address* set here and *IP address* set during Network – IP Address setup, otherwise the iSCSI changes will not be saved.

Highlight the DVR – Initiator Node Name box and press the  button. A virtual keyboard appears allowing you to enter the DVR name to be registered on the iSCSI device.

Highlight the iSCSI – Target Address box and press the  button. Use the arrow buttons to enter the IP address of the iSCSI device that you are connecting to the DVR.

Highlight the iSCSI – Target Port box and press the  button. Use the arrow buttons to enter the port number of the iSCSI device that you are connecting to the DVR.

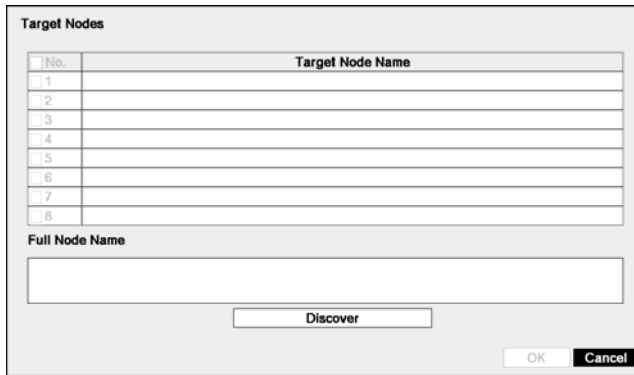

Highlight the iSCSI – Target Nodes box and press the  button, and the Target Nodes screen appears.

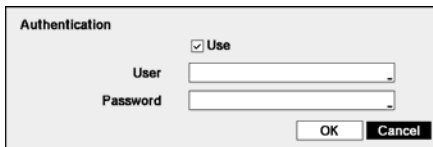

Highlight Discover and press the  button. Proper iSCSI settings will display the list of iSCSI hard disk drives currently connected to the DVR in the Target Node Name list, and selecting a specific device from the list displays its full name in the Full Node Name box. Selecting a desired device and selecting OK allows you to use the selected device for recording.

Highlight the box beside iSCSI – CHAP Authentication and press the  button. An Authentication screen appears.



Highlight Use and press the  button to toggle between On and Off. Highlight the box beside User/Password and press the  button. A virtual keyboard appears allowing you to enter the user ID and password.

NOTE: Setting up the Authentication will be required to access the iSCSI device that uses the CHAP Authentication function.

The box beside Session displays the current connection status between the DVR and iSCSI device.

NOTE: The system restarts automatically after changing the iSCSI settings.

When using an iSCSI device, refer to the device manufacturer's instructions for proper settings.

Recorded video and audio on an iSCSI device might play properly depending on network conditions.

CAUTION: The iSCSI device should be connected directly to the iSCSI connector on the rear panel of the DVR.

Event Setup

Motion

Highlight Motion and press the  button, and the Motion setup screen appears. (Local Cameras Only)

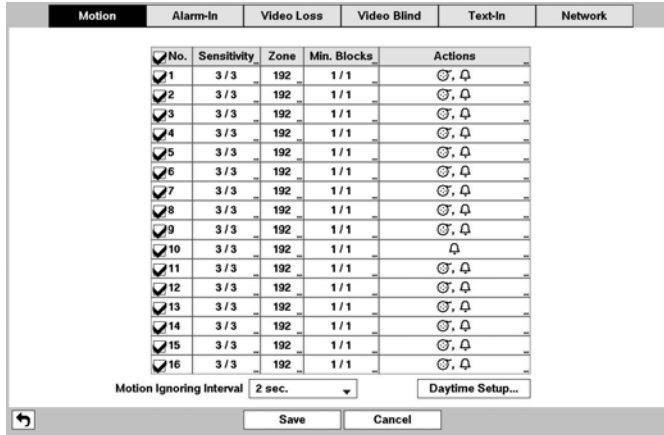
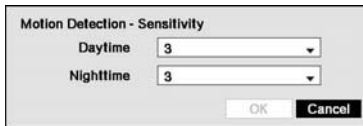

Figure 24 : Event – Motion setup screen.

Your DVR has built-in video motion detection. Video motion detection can be turned On or Off for each camera.



Highlighting the box under the Sensitivity heading and pressing the button allows you to adjust the DVR’s sensitivity to motion for Daytime and Nighttime independently. There are five settings with 1 being the least sensitive and 5 being the most sensitive.

You can define the area of the image where you want to detect motion; e.g., a doorway. Highlight the box under the Zone heading, and press the button. The Motion Detection Zone screen displays.

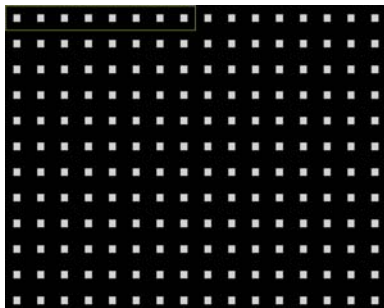

The Motion Detection Zone screen is laid over the video for the selected camera. You can set up motion detection zones by selecting or clearing blocks.

NOTE: You can set up motion zones one block at a time in groups of 8 individual block groups. A block group is positioned within the image area using the Up and Down arrow buttons, and individual blocks within the block groups are selected or cleared using the camera buttons.

Press the button to display the menu screen. The menu on the setup screen has the following functions:

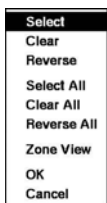

- Select — Activates highlighted blocks to detect motion.
- Clear — Deactivates highlighted blocks so that they will not detect motion.
- Reverse — Activates inactive highlighted blocks and deactivates active highlighted blocks.
- Select All — Activates all blocks to detect motion.
- Clear All — Deactivates all blocks so that they will not detect motion.
- Reverse All — Activates inactive blocks and deactivates active blocks.
- Zone View — Displays any detected motion within the zone in red.
- OK — Accepts changes and closes Zone setup.
- Cancel — Exits Zone setup without saving changes.

NOTE: Displaying the detection zone is supported only in the HD display mode.

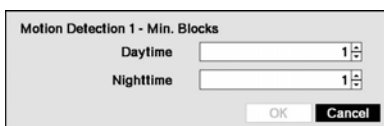

You can adjust the minimum number of detection blocks that must be activated to trigger a motion alarm. Highlighting the box under the Min. Blocks heading and pressing the button allows you to adjust the minimum number of detection blocks for Daytime and Nighttime independently. Smaller numbers provide greater sensitivity because fewer detection blocks must be activated.

Highlight the box under the **ACTIONS** and press the button. The DVR can be set to react to motion detection differently for each camera. Each camera can be associated with another camera, trigger an Alarm-Out connector, sound the DVR's internal buzzer, notify a number of different devices, move PTZ cameras to preset positions, and/or display a camera on a SPOT monitor.

You can control excessive event logging and remote notification of motions detected after the motion dwell time by adjusting the motion ignoring dwell intervals. Highlight the box beside **Motion Ignoring Interval** and press the button. A list of intervals ranging from 1 to 5 seconds or **Never** appears. The DVR will not log and notify motion events occurred during the preset interval range.

NOTE: The record action for motion events will not be affected by the Motion Ignoring function.

Highlighting **Daytime Setup** and pressing the button allows you to set up the Daytime range.



Highlight the box beside **Daytime** and press the button. Use the Up and Down arrow buttons to set the Daytime range. The DVR will consider the remaining time range as the Nighttime.

Alarm-In

Highlight **Alarm-In** and press the button, and the Alarm-In setup screen appears. (Local Cameras Only)

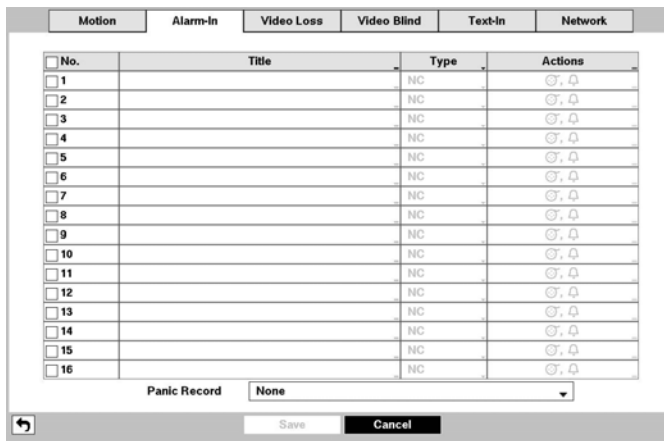

Figure 25 : Event – Alarm-In setup screen.

The alarm terminal strip on the back of the DVR has inputs associated with each alarm. You can set up each input on the **Alarm-In** screen. You can turn each input On or Off by highlighting the alarm number and pressing the button.

Each input can be given a title. Highlight the desired Title box and press the button. A virtual keyboard appears allowing you to enter a title name.

Each input can be set as NO (normally open) or NC (normally closed).

Highlight the box under the **ACTIONS** and press the button. You can set the actions the DVR will take whenever it senses an input on one of its alarm input connectors. Alarm input can be associated with cameras, trigger an Alarm-Out connector, sound the DVR's internal buzzer, notify a number of different devices, move PTZ cameras to preset positions, and/or display a camera on a SPOT monitor.

You can set up the DVR to start panic recording whenever it senses an input on one of its alarm input connectors. Highlight the box beside **Panic Record** and press the button. A list of Alarm Inputs appears, and you can select which alarm input you want associated with panic recording. The DVR will continue panic recording until an input on the selected alarm input is released as long as the **PANIC** button is not pressed to stop the panic recording.

Video Loss

Highlight Video Loss and press the  button, and the Video Loss setup screen appears. (Local Cameras Only)

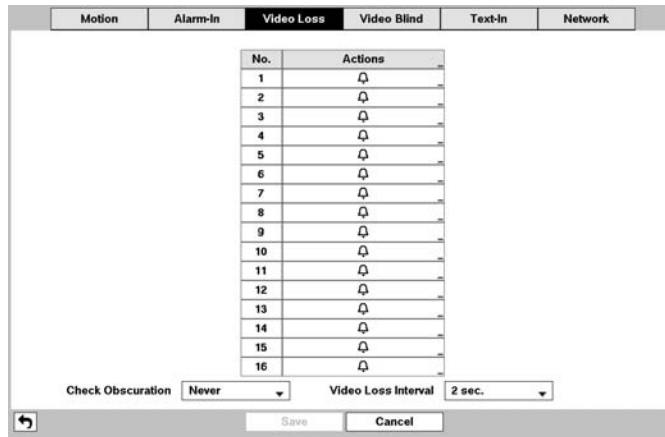



No.	Actions
1	
2	
3	
4	
5	
6	
7	
8	
9	
10	
11	
12	
13	
14	
15	
16	

Check Obscuration: Video Loss Interval:

Figure 26 : Event – Video Loss setup screen.

Highlight the box under the Actions and press the  button. The DVR can be set to react to video loss differently for each camera. Each camera can be associated with another camera, trigger an Alarm-Out connector, sound the DVR's internal buzzer, notify a number of different devices, move PTZ cameras to preset positions, and/or display a camera on a SPOT monitor.

The DVR checks to see if anything is obscuring the camera. Highlight the box beside Check Obscuration, and press the  button. A list of sensitivity ranging from 1 to 10 or Never appears. The sensitivity can be set from Never to 10 (extremely sensitive).

Highlighting the box beside Video Loss Interval and pressing the  button allows you to set the duration of a signal loss before the DVR will report a Video Loss. The DVR will not consider any signal loss from a camera to be a Video Loss if the detected signal loss is shorter than the preset interval.

Video Blind

Highlight Video Blind and press the  button, and the Video Blind setup screen appears. The DVR checks to see if anything is blinding a camera. (Local Cameras Only)

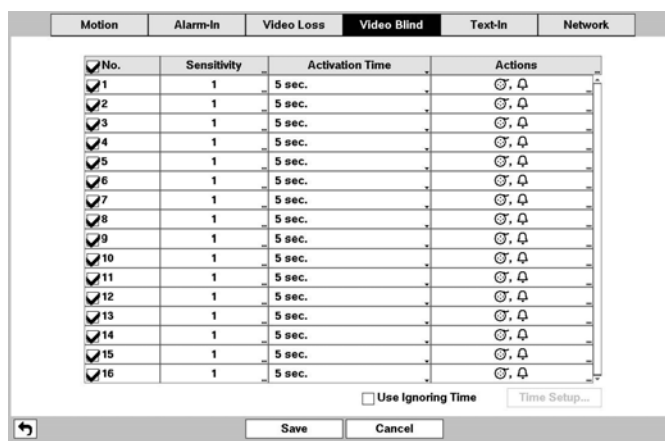

No.	Sensitivity	Activation Time	Actions
<input checked="" type="checkbox"/> 1	1	5 sec.	
<input checked="" type="checkbox"/> 2	1	5 sec.	
<input checked="" type="checkbox"/> 3	1	5 sec.	
<input checked="" type="checkbox"/> 4	1	5 sec.	
<input checked="" type="checkbox"/> 5	1	5 sec.	
<input checked="" type="checkbox"/> 6	1	5 sec.	
<input checked="" type="checkbox"/> 7	1	5 sec.	
<input checked="" type="checkbox"/> 8	1	5 sec.	
<input checked="" type="checkbox"/> 9	1	5 sec.	
<input checked="" type="checkbox"/> 10	1	5 sec.	
<input checked="" type="checkbox"/> 11	1	5 sec.	
<input checked="" type="checkbox"/> 12	1	5 sec.	
<input checked="" type="checkbox"/> 13	1	5 sec.	
<input checked="" type="checkbox"/> 14	1	5 sec.	
<input checked="" type="checkbox"/> 15	1	5 sec.	
<input checked="" type="checkbox"/> 16	1	5 sec.	

Use Ignoring Time

Figure 27 : Event – Video Blind setup screen.

You can turn individual cameras On or Off for video blind detection by highlighting the camera number and pressing the  button.





Highlighting the box under the **Sensitivity** heading allows you to adjust the DVR's sensitivity to video blind from 1 (least sensitive) to 10 (most sensitive).

NOTE: Video blind might NOT be detected for a camera with a very noisy image especially when set for low sensitivity values.

Highlighting the box under the **Activation Time** heading allows you to set the duration before the DVR will report a Video Blind. The DVR will not consider any blinded camera to be a Video Blind if the detected blindness is less than the Activation Time set on this screen.

Highlight the box under the **ACTIONS** and press the  button. The DVR can be set to react to video blind differently for each camera. Each camera can be associated with another camera, trigger an Alarm-Out connector, sound the DVR's internal buzzer, notify a number of different devices, move PTZ cameras to preset positions, and/or display a camera on a SPOT monitor.

Highlight **Use Ignoring Time** and press the  button to toggle between On and Off. When set to On, the DVR will ignore video blind events occurred during the preset period. Highlighting **Time Setup** and press the  button allows you to set up event ignoring time.

Text-In

Highlight **Text-In** and press the  button, and the Text-In setup screen appears. (Local Cameras Only)

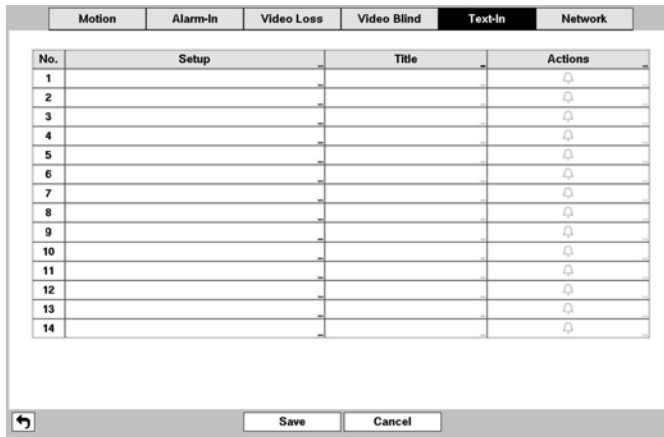



Figure 28 : Event – Text-In setup screen.

The DVR can be set to react to text input from devices such as ATMs (Automated Teller Machines) and POS (Point of Sale; i.e., cash registers). This screen allows you to configure the DVR for each text-in device.

Highlight the box under the **Setup** heading, and press the  button. Selecting the **Setup** heading changes all the parameters excluding Port settings of all the text input channels.

NOTE: The system performance might be affected when a large quantity of text inputs are detected from several channels at the same time.

Figure 29 : Text-In Device screen.

Highlight the box beside **Port**, and press the button. Select from None, RS232, RS485, USB-Serial (1~8) and LAN (1~16).

NOTE: If you have set the Port as None, you will not be able to make any changes to the screen.

When using the USB to serial text-in device, do NOT remove the USB cable from the port while the system is running.

Highlight **Setup...**, and press the button. Use the ATM or POS manufacturer's recommended settings when configuring the RS232, RS485, USB-Serial or LAN ports.

Highlight the box beside **Text-In Product**, and press the button. Select your device from the list.

NOTE: The following description is for a Generic Text Device. The screen changes for different types of text input devices, and there will be different parameter boxes for you to enter information.

Highlight the box beside **Transaction Start**, and press the button. Use the virtual keyboard to enter the Transaction Start string. Refer to the device manufacturer's documentation for the text string that the device first sends when a transaction starts.

If you want the DVR to react to any character sent from the text input device, you will want to turn On **Any Character**. Highlight **Any Character**, and press the button to toggle between On and Off.

NOTE: If *Any Character* is turned On, you will not be able to enter any text in the *Transaction Start* box.

Highlight the box beside **Transaction End**, and press the button. Use the virtual keyboard to enter the Transaction End string. Refer to the device manufacturer's documentation for the text string that the device sends when a transaction ends.

Highlight the **more line(s)** box, and press the button. Select the number of additional lines of text that you want the DVR to record. You can choose from 0 to 10.

Highlight the box beside **Line Delimiter**, and press the button. Use the virtual keyboard to enter the character(s) that the device uses to indicate the end of a line. Special characters can be created using ^ and a capital letter; e.g., ^J for NL (New Line), ^M for CR (Carriage Return). Refer to the device manufacturer's documentation for Line Delimiter character(s).

Highlight the box beside **Ignore String**, and press the button. Use the virtual keyboard to enter any strings of text that you want the DVR to ignore. Refer to the device manufacturer's documentation for text strings that the device sends during transactions, so you will know which ones you do not want recorded.

Highlight the **Case Sensitive** box, and press the button to toggle between On and Off. Refer to the device manufacturer's documentation to determine if the text strings are Case Sensitive. If the device distinguishes between upper and lower case letters, make certain the **Case Sensitive** box is turned On.

Highlight the box beside **Time Out**, and press the button. Set the length of time to wait for the new text string. The DVR will consider a transaction complete if no new text strings are entered between the last text input and the dwell time out. You can adjust the Time Out dwell from 5 seconds to 15 minutes.

Highlight the box under the **Actions** and press the button. The DVR can be set to react to text input. Text input can be associated with cameras, trigger an Alarm-Out connector, sound the DVR's internal buzzer, notify a number of different devices, move PTZ cameras to preset positions, and/or display a camera on a SPOT monitor.

Network

Highlight **Network** and press the button, and the Network setup screen appears. (Network Devices Only)

Event	Use	Actions	Dwell Time
NETCAM17			
NETCAM18			
NETCAM19			
NETCAM20			
NETCAM21			
NETCAM22			
NETCAM23			
NETCAM24			
NETCAM25			
NETCAM26			
NETCAM27			
NETCAM28			
NETCAM29			
NETCAM30			
NETCAM31			
NETCAM32			

Figure 30 : Event – Network setup screen.

Highlighting the box under the **Event** and pressing the button displays events that occurred on the network device channel that you selected.

NOTE: Displaying events is supported when the network device is networked with the DVR.

Highlighting the box under the **Use** and pressing the button turns each selected event On and Off.

Highlighting the box under the **Actions** and pressing the button selects how the DVR reacts to network devices events. The network devices events can be associated with cameras, trigger an Alarm-Out connector, sound the DVR's internal buzzer, notify a number of different devices, move PTZ cameras to preset positions, and/or display associated local cameras on a SPOT monitor.

NOTE: For the event detection and action to work, the event-related settings for network devices should set properly.

Highlighting the box under the **Dwell Time** and pressing the button allows you to set the dwell time of network devices events. Dwell times range from 1 second to 15 seconds or Not Using.

Device Setup

Local Audio

Highlight **Local Audio** and press the button, and the Local Audio setup screen appears.

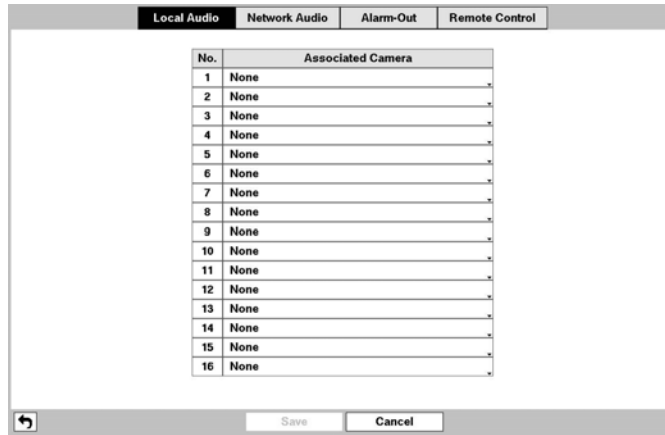



Figure 31 : Device – Audio setup screen.

The DVR can record up to 16 audio inputs. Highlight the box beside the input and press the  button. A list of local cameras appears, and you can select which camera you want associated with that audio input.

Network Audio

Highlight Network Audio and press the  button, and the Network Audio setup screen appears.

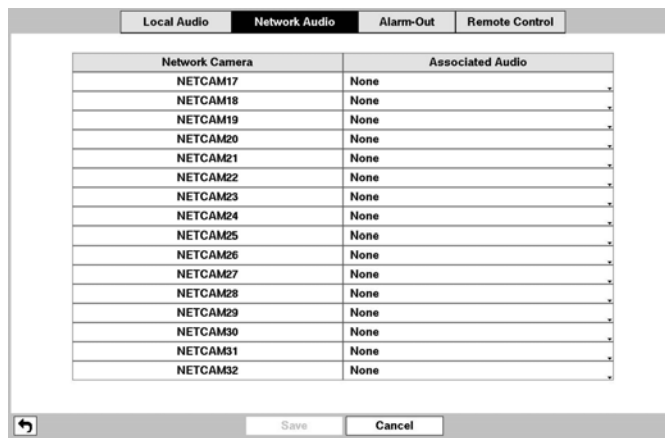



Figure 32 : Device – Network Audio setup screen.

Highlight the box beside the network device input and press the  button. A list of local audio channels appears, and you can select which audio channel you want associated with that network device input. Audio from the selected channel will be sent to the network device that is associated with.

Alarm-Out

Highlight Alarm-Out and press the  button. The Alarm-Out screen allows you to change the settings and establish a schedule for each alarm output from the DVR.

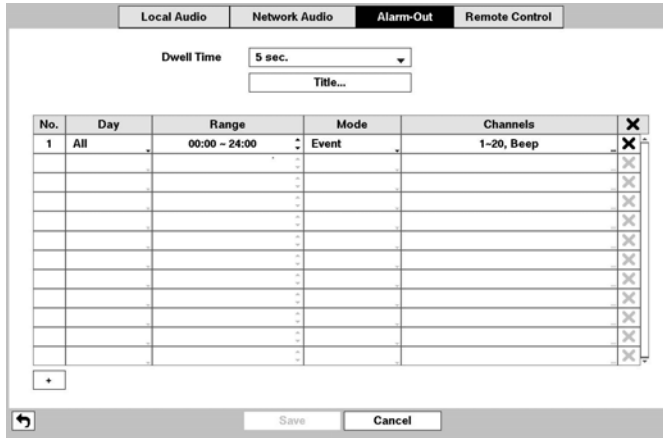







Figure 33 : Device – Alarm-Out setup screen.

Highlighting the box beside Dwell Time and pressing the  button allows you to set the dwell time of the alarm output. Dwell times range from 5 seconds to 15 minutes.

Each alarm output can be given its own title by highlighting Title... and pressing the  button. A virtual keyboard appears allowing you to enter the title.

You can add and edit alarm output schedules. Highlight the + and press the  button to add a schedule. Highlighting the boxes under the Column heading and pressing the  button allows you to edit the information in those boxes.

Highlighting the boxes under the Day box and pressing the  button allows you to select the days that the alarm schedule will be active. The choices are: Sun, Mon, Tue, Wed, Thu, Fri, Sat, M~F, Hol and All.

Highlighting the boxes under the Range box and pressing the  button allows you to set the time that the alarm schedule will be active in 15-minute increments from 00:00 to 24:00.

Highlighting the boxes under the Mode box and pressing the  button allows you to set how the alarm reacts during the scheduled time. When set to On, the Alarm-Out is active during the scheduled time. When set to Event, the Alarm-Out is only active when there is an Event during the scheduled time.

Highlighting the boxes under the Channels box and pressing the  button allows you to set which alarm outputs will be active. You can also select the DVR's internal buzzer.

The X box allows you to delete an alarm output schedule. You will be asked to confirm whether or not you really wish to delete the schedule.

Remote Control

Highlight Remote Control and press the  button. The Remote Control setup screen allows you to select a port and make correct settings for a remote keyboard.



Figure 34 : Device – Remote Control setup screen.

Highlight the box beside **Port** and select from None, RS232 and RS485. If the RS232 port and RS485 port are in use for PTZ control, networking or text input, the remote keyboard cannot be configured.

Highlight **Setup...** and select the correct Baud Rate, Parity, Data Bits and Stop Bits for the device you are connecting to the DVR.

Highlight the box beside **Remote Control Product** and select the device from the list.

Display Setup

OSD

Highlight OSD and press the  button. The OSD screen allows you to select what information will be displayed on the monitor.

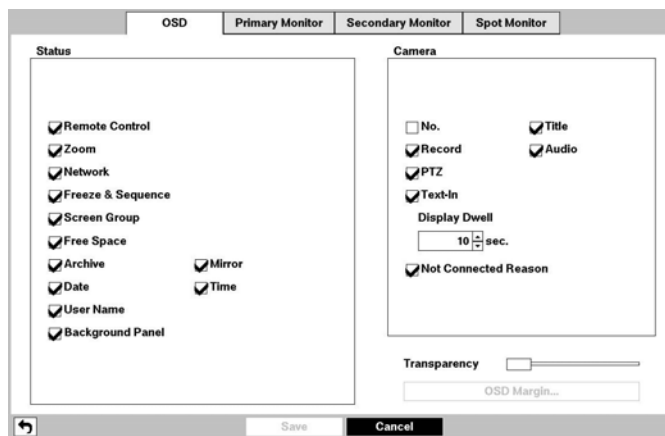















Figure 35 : Display – OSD setup screen.

Highlighting an item and pressing the  button toggles that item On and Off. When an item is On, there is a checkmark in the box beside it. The following items can be turned On or Off:

- Remote Control – The icon  displays when the DVR can be controlled by the infrared remote control.
- Zoom – The icon  displays on the enlarged video.

- **Network** – The icon  displays when the unit is connected to a network via Ethernet. The icon  displays on each camera when audio communication is available between the DVR and a PC running ATVision via Ethernet. The icon  displays when VNC service is running.
- **Freeze & Sequence** – The icon  displays while in the Freeze mode, and the icon  displays while in the Sequence mode.
- **Screen Group** – The number of screen group displays when the DVR is not in the 4x4 display mode.
- **Free Space** – The icon  displays when the DVR is in the Recycle mode, and the percentage of available storage space displays when the DVR is not in the Recycle mode.
- **Archive** – The icon  displays when the DVR is archiving recorded data.
- **Mirror** – The icon  displays when the DVR is disk mirroring.
- **Date/Time** – The current date and time information displays.
- **User Name** – The name of the current user logged in displays.
- **Background Panel** – The background panel at the bottom of the screen displays in black.
- **Camera No.** – The camera number displays at the top-left corner of each camera screen.
- **Camera Title** – The camera title displays at the top-left corner of each camera screen.
- **Record** – The record related icons display on each camera screen.
- **Audio** – The icon  displays on each camera screen for which the DVR can play live audio.
- **PTZ** – The icon  displays on each PTZ camera screen.
- **Text-In** – The text input strings display on the screen. You can adjust the Display Dwell time (sec.) for the text input strings displayed on the screen.
- **Not Connected Reason** – The error code displays on the associated camera screen when the network device is not connected properly. Refer to *Appendix – Error Code Notices* for error code information.

You can adjust the transparency of the setup screens by highlighting **Transparency** and using the Left and Right arrow buttons.

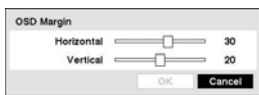

Highlighting **OSD Margin...** and pressing the  button displays how OSD text will be displayed on the monitor. You can adjust the horizontal and vertical margins so that text and icons will not be hidden beyond the edges of the monitor.

NOTE: Adjusting the OSD margin is supported only in the SD display mode.

Primary Monitor

Highlight **Primary Monitor** and press the  button, and the Primary Monitor setup screen appears.



Figure 36 : Display – Primary Monitor setup screen.

Highlight the box beside **Mode** and press the  button. You can select between Full Sequence and Cameo Sequence.

Pressing the **SEQUENCE** button on the remote control or selecting  (Sequence) in the Live Monitoring menu causes the DVR to sequence cameras, and the DVR can sequence cameras in two modes: “Full” and “Cameo”. In the Full mode, the DVR sequences through the cameras and displays them full screen. In the Cameo mode, the bottom right window in a multi-screen format sequences through the cameras.

NOTE: Any cameras that are Off, have lost video or are set to Covert (unless the user has authority to view covert cameras) will be excluded from the Cameo sequence.

You can define the screen layout in a variety of formats and set the DVR to sequence through the different screen layouts (pages) so that all the cameras will be displayed. You can also set up the DVR to display one camera or a group of cameras all the time while cycling through the remaining cameras in a “cameo” window. This can be done with one camera displayed full screen while displaying the cameras in a grid pattern with the bottom right window as the cameo.

NOTE: Sequence cannot be used in the 4x4 display mode.



You can adjust the display dwell time by highlighting the box beside **Interval** and pressing the  button. You can select dwell intervals ranging from 3 seconds to 2 minutes.



Highlight the box beside **Event Monitoring** and press the  button. You can select the event monitoring mode from **None**, **Local Camera** and **Network Camera**. Selecting **Local Camera** displays local cameras associated with the event, and selecting **Network Camera** displays network cameras associated with the event.

NOTE: “Network Camera” includes both network cameras and network video transmitters.



Displaying cameras associated with the event from both local cameras and network devices at the same time is not supported.



Highlight the box beside **Resolution** and press the  button. You can select from 1280x1024, 1440x900, 1600x900, 1680x1050 and 1920x1080 for NTSC video, and 1280x1024, 1440x900, 1600x900, 1680x1050 and 1920x1080 (@ 60Hz or 50Hz) for PAL video.



Highlight the box beside **Set Resolution to Manual Mode** and press the  button. Pressing the  button toggles between **On** and **Off**. When it is **On**, you can set the resolution manually regardless of the resolution supported by the monitor.

Highlight the box beside **Hide Unsupported Resolution** and press the  button. Pressing the  button toggles between **On** and **Off**. When it is **On**, the unsupported resolution on the connected monitor will not be shown.

NOTE: When selecting unsupported resolution, video might NOT be displayed on the monitor screen. In this case, pressing the  button for more than five seconds will change to the different frequency (Hz) resolution or restart the system and display video with the maximum resolution supported on the monitor.

Highlight **Fit To Screen** and press the  button. Pressing the  button toggles between **On** and **Off**. When it is **On**, the DVR will resize video to fit the primary monitor screen.

Highlight the box beside **Apply Monitor Information** and press the  button. Pressing the  button toggles between **On** and **Off**. When it is **On**, the DVR will provide clearer display by applying the monitor information.

Highlight the box beside **HDMI Mode** and press the  button. Pressing the  button toggles between **On** and **Off**. When it is **On**, the DVR will optimize the HDMI video out.

NOTE: The system restarts automatically after changing the resolution settings. If the system restarts when the monitor is not connected, the resolution will be set to 1280x1024@60Hz as default without saving your changes.

When the individual primary monitors are connected to the HDMI and VGA connectors for simultaneous operation, it is recommended to use monitors supported with the same resolution. If monitors unsupported with the same resolution are connected, video might not be displayed on either of the two monitors.

Secondary Monitor

Highlight **Secondary Monitor** and press the  button, and the Secondary Monitor setup screen appears.



Figure 37 : Display – Secondary Monitor setup screen.

Highlight the box beside Mode and press the button. You can select between Full Sequence and Cameo Sequence.

Pressing the **SEQUENCE** button on the remote control or selecting (Sequence) in the Live Monitoring menu causes the DVR to sequence cameras, and the DVR can sequence cameras in two modes: “Full” and “Cameo”. In the Full mode, the DVR sequences through the cameras and displays them full screen. In the Cameo mode, the bottom right window in a multi-screen format sequences through the cameras.

NOTE: Any cameras that are Off, have lost video or are set to Covert (unless the user has authority to view covert cameras) will be excluded from the Cameo sequence.

You can define the screen layout in a variety of formats and set the DVR to sequence through the different screen layouts (pages) so that all the cameras will be displayed. You can also set up the DVR to display one camera or a group of cameras all the time while cycling through the remaining cameras in a “cameo” window. This can be done with one camera displayed full screen while displaying the cameras in a grid pattern with the bottom right window as the cameo.

NOTE: Sequence cannot be used in the 4x4 display mode.

You can adjust the display dwell time by highlighting the box beside Interval and pressing the button. You can select dwell intervals ranging from 3 seconds to 2 minutes.

NOTE: Monitoring and playing back video from network devices is not supported on the secondary monitor.

Spot Monitor

Highlight Spot Monitor and press the button, and the Spot Monitor setup screen appears.

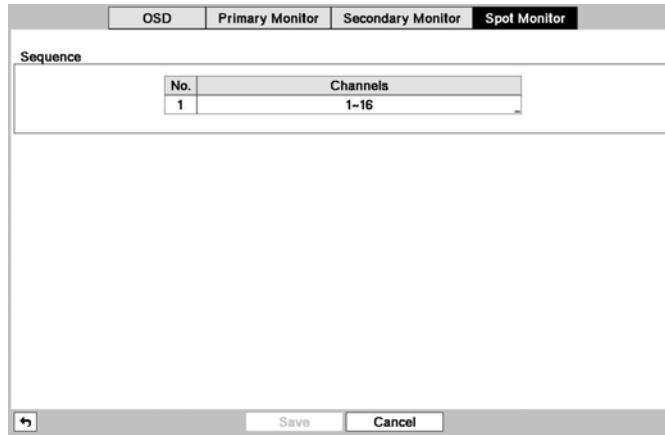

Figure 38 : Display – Spot Monitor setup screen.

Highlight the box in the Channels column and press the button.

Spot Monitor: Channels		Camera	Dwell	Camera	Dwell
<input checked="" type="checkbox"/>	1. CAM1	1 sec.	<input checked="" type="checkbox"/>	9. CAM9	1 sec.
<input checked="" type="checkbox"/>	2. CAM2	1 sec.	<input checked="" type="checkbox"/>	10. CAM10	1 sec.
<input checked="" type="checkbox"/>	3. CAM3	1 sec.	<input checked="" type="checkbox"/>	11. CAM11	1 sec.
<input checked="" type="checkbox"/>	4. CAM4	1 sec.	<input checked="" type="checkbox"/>	12. CAM12	1 sec.
<input checked="" type="checkbox"/>	5. CAM5	1 sec.	<input checked="" type="checkbox"/>	13. CAM13	1 sec.
<input checked="" type="checkbox"/>	6. CAM6	1 sec.	<input checked="" type="checkbox"/>	14. CAM14	1 sec.
<input checked="" type="checkbox"/>	7. CAM7	1 sec.	<input checked="" type="checkbox"/>	15. CAM15	1 sec.
<input checked="" type="checkbox"/>	8. CAM8	1 sec.	<input checked="" type="checkbox"/>	16. CAM16	1 sec.

OK Cancel

You can define which cameras display sequentially on the Spot Monitor when in the single-screen display format. Highlighting the box under the Camera and pressing the button toggles between On and Off.

You can adjust the display dwell time by highlighting the box under the Dwell and pressing the button. You can select dwell intervals ranging from 1 to 20 seconds.

Pressing the **SEQUENCE** button on the remote control or selecting (Sequence) in the Live Monitoring menu causes the DVR to sequence cameras.

NOTE: Sequence cannot be used in the 4x4 display mode.

Monitoring and playing back video from network devices is not supported on the SPOT monitor.

Status Setup

Event

Highlight Event and press the button, and the Event setup screen appears.

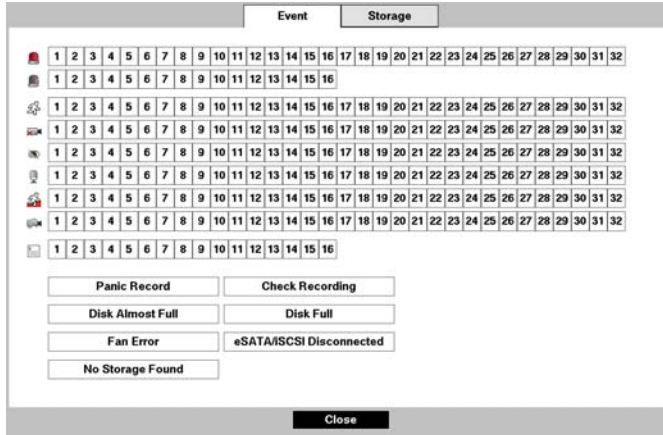

Figure 39 : Status – Event setup screen.

The Event Status screen displays the status of the DVR’s systems and inputs. Events will be highlighted, and related channels or events will flicker for five seconds when detected.

(Alarm-In), (Motion), (Video Loss), (Video Blind) and (Text-In) will be highlighted when each event is detected based on the settings you made in the Alarm-In, Motion, Video Loss, Video Blind and Text-In setup screen on the Event menu. (Audio), (Trip-Zone) and (Tampering) will be highlighted when each event is detected based on the settings you made in the Network setup screen on the Event menu.

(Check Alarm-In) and Check Recording will be highlighted when each event is detected based on the settings you made in the Monitoring setup screen on the System menu.

Panic Record will be highlighted while the DVR is in the panic recording mode.

Disk Almost Full will be highlighted when the DVR is not in the Recycle mode and the level of disk usage reaches the Disk Almost Full percentage you made in the System Event setup screen on the Event menu. Disk Full will be highlighted when the DVR is not in the Recycle mode and all available storage space has been used.

Fan Error will be highlighted when the cooling fan to the left of the power cord on the rear panel is not working for more than four seconds.

eSATA/iSCSI Disconnected will be highlighted when the eSATA or iSCSI device is disconnected.

No Storage Found will be highlighted when there is no storage device for recording is installed in the DVR when the DVR boots for the first time.

Storage

Highlight Storage and press the button, and the Storage setup screen appears.

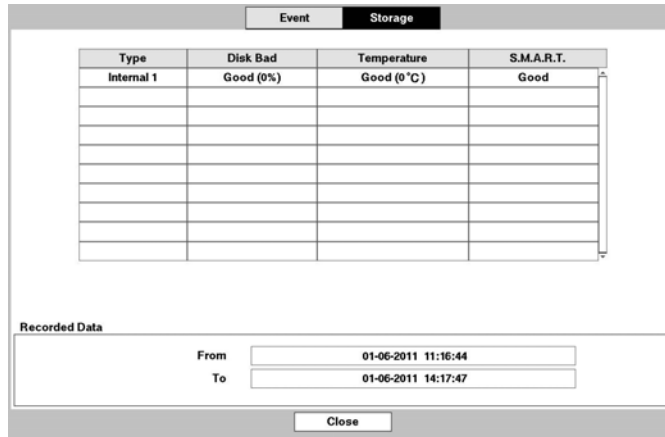

Figure 40 : Status – Storage setup screen.

The **Type** column displays the type of storage device.

The **Disk Bad** column displays the percentage of bad sectors. **Not formatted** indicates the device is not formatted.

The **Temperature** column displays the temperature of the storage device.

The **S.M.A.R.T.** column displays “Good”, “Bad” or “N/A”, depending on storage conditions.

- Good – The storage condition is normal.
- Bad – Data cannot be written on or read from the storage device.
- N/A – Storage conditions are normal, however, the S.M.A.R.T. monitoring is not working or supported.

NOTE: When the storage condition is “Bad”, the Event Status – Storage screen displays and you can check the storage condition for details. Once the “Bad” message displays, replacing the hard disk drive is recommended, usually within 24 hours.

Temperature and *S.M.A.R.T.* information will be available only for internal hard disk drives supporting the SMART (Self-Monitoring Analysis and Reporting Technology) monitoring program.

The box beside Recorded Data – From / To displays the time information of recorded data.

Camera Setup

General

Highlight General and press the  button, and the General setup screen appears. (Local Cameras Only)

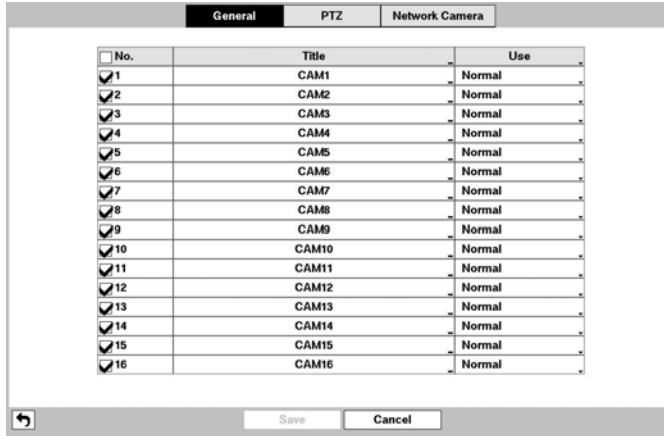

Figure 41 : Camera – General setup screen.

You can turn the camera number On or Off, and you can change the Title of each camera using the virtual keyboard. You can also determine which cameras will display on the monitors by selecting Normal, Covert 1 or Covert 2 from a drop-down list in the Use column.

NOTE: When selecting the *Covert 1*, the DVR displays the camera title and status icons on the covert video. When selecting the *Covert 2*, the DVR displays only camera title on the covert video.

A user who does not have *Covert Camera View* authority cannot view video from cameras set to *Covert 1* or *Covert 2* in both the live monitoring and playback modes.

PTZ

Highlight PTZ and press the button, and the PTZ setup screen appears. (Local Cameras Only)

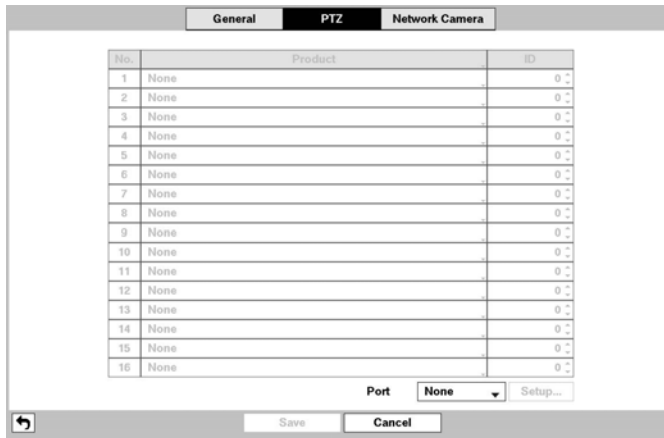

Figure 42 : Camera – PTZ setup screen.

NOTE: You will only be able to set up PTZ devices if the PTZ port is set to RS232 or RS485.



Highlight the box in the Product column for the PTZ camera you wish to configure and press the button. A list of PTZ devices appears. Select your camera from the list and press the button. You will need to connect the camera to the RS232 or RS485 connector on the back of the DVR following the camera manufacturer's instructions.

You can assign IDs to each camera by highlighting the box under the ID heading and pressing the button. Change the number by highlighting it and using the Up and Down arrow buttons to increase and decrease the number. The PTZ ID number can be set from 0 to 256.

Highlight the Setup... box and press the button. The Port Setup window appears.

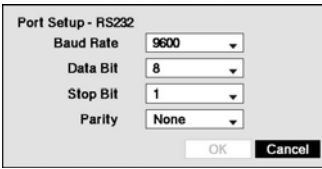

Configure the port's setting based on the PTZ camera manufacturer's instructions.

Network Camera

Highlight Network Camera and press the button, and the Network Camera setup screen appears. (Network Devices Only)

NOTE: "Network Camera" includes both network cameras and network video transmitters.

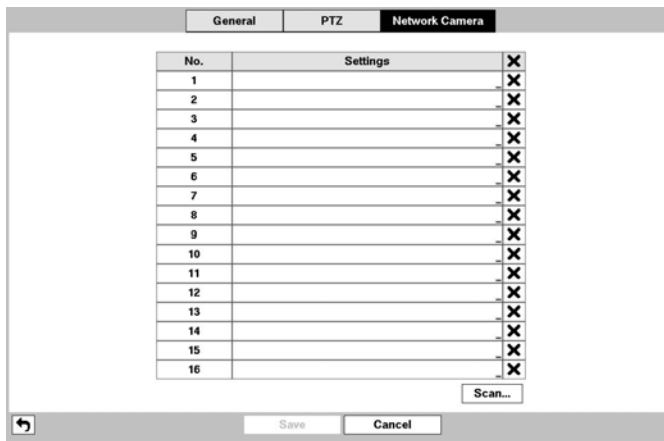
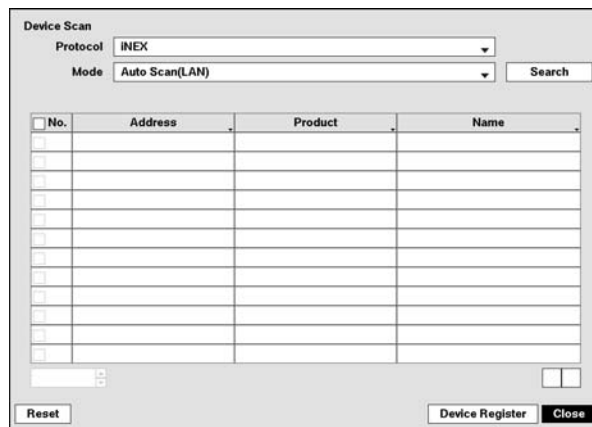

Figure 43 : Camera – Network Camera setup screen.



Highlight the Scan... box and press the button, and the Device Scan setup screen appears.



Highlighting the box beside Protocol and pressing the button allows you to select the protocol for the network device you want to search.

NOTE: Some event related functions may not be supported for network devices that use protocols other than *iNEX*, and some other functions may not be supported depending on the settings of the device. Detecting video signal loss is supported for all network devices regardless of their protocol.

Refer to the network device manufacturer's instructions about enabling the ONVIF™ Conformance protocol in the device, as procedures may differ for each model.

Highlight the box beside Mode, and press the  button. You can select the scan mode from: Auto Scan (LAN), IP Address Scan, DVRNS Scan and Domain Name Scan. Select the desired mode and press the  button.

NOTE: The supported scan modes differ depending on the protocol you selected.

If the IP address range of the device is different from that of the DVR, the DVR considers the IP address invalid. In this case, you must change the device's IP address to register the device. Changing the device's IP address when registering the network device to the DVR will be supported for some of network devices using the iNEX protocol.

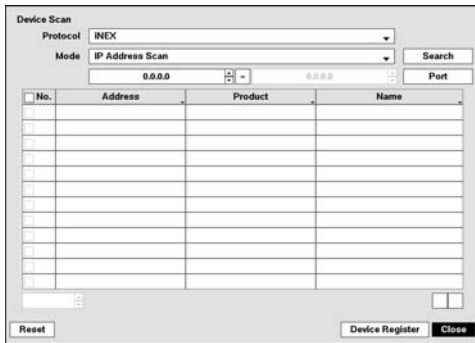

The screenshot shows the 'Device Scan' window with 'Protocol' set to 'iNEX' and 'Mode' set to 'IP Address Scan'. The 'Address' field contains '0.0.0.0' and the 'Port' field is empty. Below the input fields is a table with columns 'No.', 'Address', 'Product', and 'Name'. At the bottom, there are 'Reset', 'Device Register', and 'Close' buttons.

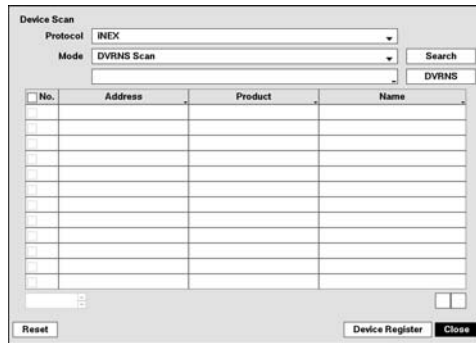

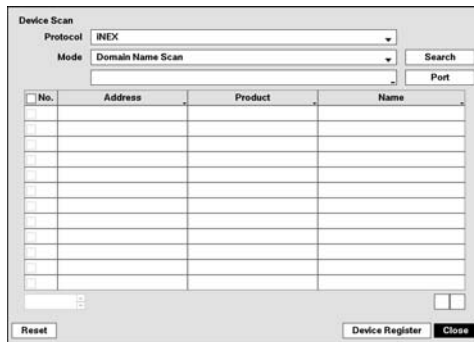

The screenshot shows the 'Device Scan' window with 'Protocol' set to 'iNEX' and 'Mode' set to 'DVRNS Scan'. The 'Address' field contains '0.0.0.0' and the 'Port' field is empty. Below the input fields is a table with columns 'No.', 'Address', 'Product', and 'Name'. At the bottom, there are 'Reset', 'Device Register', and 'Close' buttons.



The screenshot shows the 'Device Scan' window with 'Protocol' set to 'iNEX' and 'Mode' set to 'Domain Name Scan'. The 'Address' field is empty and the 'Port' field is empty. Below the input fields is a table with columns 'No.', 'Address', 'Product', and 'Name'. At the bottom, there are 'Reset', 'Device Register', and 'Close' buttons.

Selecting Auto Scan (LAN) from Mode scans network devices automatically.

Selecting IP Address Scan from Mode scans network devices by entering a specific IP address or adjusting the IP address range. Highlighting Port and pressing the  button allows you to set the port number used for remote monitoring.

Selecting DVRNS Scan from Mode scans network devices by entering the IP address or domain name of the network device. Highlighting DVRNS and pressing the  button allows you to set the port number of the DVRNS server.

NOTE: For the DVRNS Scan feature to work, the network device should be registered on the DVRNS server.

Selecting Domain Name Scan from Mode scans network devices by entering the domain name of the network device. Highlighting Port and pressing the  button allows you to set the port number used for remote monitoring.

NOTE: For the Domain Name Scan feature to work, the DNS server should be configured during Network – IP Address setup.

Using the IP Address Scan, you can search for a network device that cannot be searched for using the Auto Scan (LAN) mode.



After selecting the desired scan mode, highlighting Search and pressing the  button, the system searches for network devices and displays them in the list. Selecting Reset allows you to delete the search results list.

NOTE: Depending on the model of network device, the device may not be supported even though the DVR supports the device's protocol. Ask your dealer or distributor about supported device models.

Highlight Device Register and press the  button to register the selected network device(s) from the list. An Authentication screen appears. Setting up the Authentication is required to register the network device to the DVR.

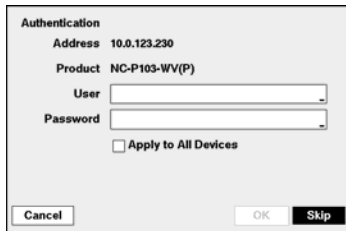
NOTE: If the IP address range of the device is different from that of the DVR, a setup screen appears allowing you to change the device's IP address. (Changing the device's IP address when registering the network device to the DVR is supported for some network devices using the iNEX protocol.)



Highlight the box beside User/Password and press the  button. A virtual keyboard appears allowing you to enter the user ID and password. Highlight Apply to All Devices and press the  button to apply the same authentication information to all the network devices in the list. When selecting multiple network devices in the list, selecting Skip skips the authentication settings for the current network device and displays the Authentication screen of the next network device.



NOTE: When registering a four-channel network video transmitter using the iNEX protocol, all four cameras are counted regardless of whether or not some or all cameras are disabled.

Proper registration and authentication settings will display registered devices in the list of the Network Camera setup screen. Highlighting the box under the Settings heading and pressing the  button allows you to change the device settings.

NOTE: The Settings screen will differ depending on the type of protocol that you selected. The following description is for a network device using the iNEX protocol.



Highlight Enable and press the  button to toggle between On and Off. When it is On, you will be able to change the device settings.

Highlight the box beside Name and press the  button. A virtual keyboard appears allowing you to edit the device name. Highlight Device Name Sync and press the  button to toggle between On and Off. When it is On, the DVR will automatically update the name based on the settings in the device.

You can assign IDs to each camera by highlighting the box beside Camera ID and pressing the  button. Change the number by highlighting it and using the Up and Down arrow buttons to increase and decrease the number. (4-ch Network Video Transmitter Only)

Highlight the box beside Network Type and press the  button. Selecting IP allows you to change the IP address of the device, and selecting DVRNS allows you to change the IP address or domain name of the device.

Network Device using iNEX Protocol

Highlight the box beside User/Password and press the  button. A virtual keyboard appears allowing you to enter the user ID and password used when changing device settings.

Highlight the Port Number Setup... box and press the  button. The Port Number Setup screen appears.

NOTE: You will need to get the appropriate Port Numbers for each program (Admin, Watch, Record and Audio) from your network administrator.

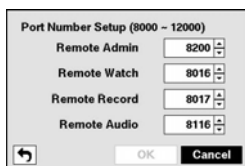



Change the numbers by highlighting them and using the Up and Down arrow buttons to increase or decrease the number. The factory default Port settings are:

Remote Admin:	8200
Remote Watch:	8016
Remote Record:	8017
Remote Audio:	8116

NOTE: Do NOT use the same port number for two different programs, otherwise, the DVR cannot connect to the network device.

CAUTION: When changing port settings, you must change the port settings on the network device. Refer to the network device manual for details.

Highlight Authentication and press the  button. An Authentication screen appears, and entering Authentication information is required to change the device settings.

Highlight the box beside Multi Stream and press the  button to select which stream will be applied for live monitoring when in the multi-view display format. Selecting Set to Manual allows you to select the desired stream manually in the Live Monitoring – Camera, Multi Stream Menu.

NOTE: When the network device has more than one stream, a different stream can be used depending on the screen display format. Refer to the network device manufacturer's instructions for details.

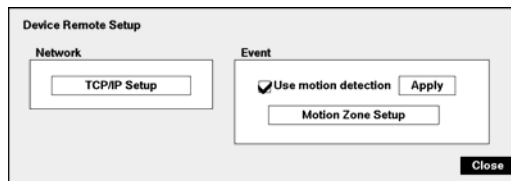

Highlight Use Audio Recording and press the  button to toggle between On and Off. When it is On, the DVR will record audio from the device when the video from the network device is recording.

Highlight the Device Remote Setup box and press the  button. The Device Remote Setup screen appears.

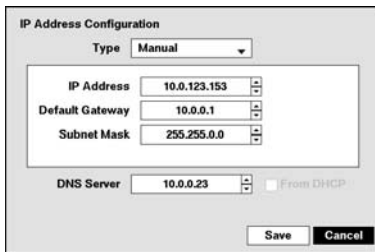

Highlight Network – TCP/IP Setup and press the  button. You can change the network settings of the network device.



Highlight the box beside Type and press the  button. You can select the type of network configuration from: Manual, DHCP and ADSL (with PPPoE). Select the desired type and press the  button. Setting up the IP Address is nearly identical to setting up the DVR IP Address. Please refer to *IP Address Setup Screen* in this chapter for more detailed instructions on setting up the network configuration.

Highlight From DHCP and press the  button to toggle between On and Off. When it is On, the network device will obtain the IP address of the DNS server automatically from the DHCP server.

Highlight Event – Use motion detection and press the  button to toggle between On and Off. Highlighting Apply applies the changes to the network device.

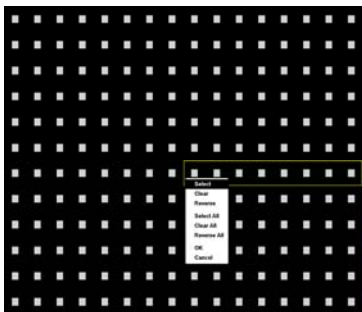

Highlight Event – Motion Zone Setup and press the  button. The motion zone screen displays. Setting up the motion zone is nearly identical to setting up the DVR for Motion Detection. Please refer to *Motion Setup Screen* in this chapter for more detailed instructions on setting up the motion zone.

NOTE: The following description is for a network device using the ONVIF™ Conformance protocol.

Network Device using Onvif
Conformance Protocol

Highlighting the box beside **Stream Protocol** and pressing the button allows you to select the protocol for streaming.

Highlighting the box beside **Record Protocol** and pressing the button allows you to select the protocol for recording.

Highlighting the box beside **ONVIF Profile** and pressing the button allows you to select a preset ONVIF™ profile.

Highlighting the **Port Number Setup...** box and pressing the button allows you to select the HTTP server's port number and the RTSP server's port number.

Highlight **Authentication** and press the button. An Authentication screen appears, and entering Authentication information is required to change the device settings.

Highlight **Use Audio Recording** and press the button to toggle between On and Off. When it is On, the DVR will record audio from the device when video from the network device is recording.

Highlight the **Device Remote Setup** box and press the button. The **Device Remote Setup** screen appears. See *Appendix – Remote Setup of Network Devices* for details.

NOTE: When the device's settings have been changed using the tool provided by the device manufacturer, you might need to register the device to the DVR again for proper operation. Refer to the device manufacturer's instructions for proper settings.

Chapter 4 — Operation

NOTE: This chapter assumes your DVR has been installed and configured. If it has not, please refer to Chapters 2 and 3.

The DVR's controls are similar to a VCR. As with a VCR, the main functions are recording and playing back video. However, you have much greater control over recording and playing back video. You can establish recording schedules based on time of day and day of the week. The DVR allows you to search through the recorded video using much more sophisticated tools than those available with VCRs. Additional DVR features that are not available with VCRs are remote control and viewing, and recording video at the same time you are watching previously recorded video.

The front panel controls are described in *Chapter 3 — Configuration*.

Turning on the Power

Once you have installed the DVR following the instructions in *Chapter 2 — Installation*, it is ready to record.

NOTE: Depending on the monitor display mode between HD mode and SD mode, the menu layout of monitor screen will be different. For simplicity, the menus and descriptions in this manual refer to the HD display mode.

Live Monitoring

As soon as the DVR completes its initialization process, it will begin showing live video on the attached monitor and playing live audio through the attached speaker. The default mode is to display all cameras at once. Pressing any camera button will cause that camera to display full screen. It displays live video and plays live audio until the user enters another mode.

While in the live monitoring mode, pressing the **MENU** button displays the following Live Monitoring menu on the right edge of the screen. Pressing the **MENU** button again hides the menu. You can navigate through menus and items by pressing the arrow buttons.





Figure 44 : Live Monitoring menu.





NOTE: The Live Monitoring menu also can be displayed by moving the mouse pointer to the right edge of the screen.

Live Monitoring Menu



Login/Logout

Selecting  (Login) in the Live Monitoring menu accesses the Login screen, and you will be asked to select a User and enter the password to log into the system. Selecting  (Logout) in the Live Monitoring menu displays the Logout screen asking you to confirm whether or not you want to log out the current user.

Monitor

Selecting  (Monitor) in the Live Monitoring menu will allow you to select the monitor from Primary, Secondary and Spot. It is the same as pressing the **MONITOR** button. Selecting Primary displays , Secondary displays  and Spot displays . You can select the screen format and sequence monitoring of the selected monitor.





Display

- **Local Camera:** Selecting  (Display) → Local Camera and choosing the camera number displays the selected local camera full screen. It is the same as pressing the individual camera buttons on the front panel or clicking the left mouse button on a camera image when in one of the multiview formats (i.e., 2x2, 3x2, 3x3, 4x3 or 4x4). Clicking the left mouse button on the screen again returns to the previous display mode.
- **Network Camera:** Selecting  (Display) → Network Camera and choosing the camera number displays the selected network camera full screen. It is the same as pressing the individual camera buttons on the front panel or clicking the left mouse button on a camera image when in one of the multiview formats (i.e., 2x2, 3x2, 3x3, 4x3 or 4x4). Clicking the left mouse button on the screen again returns to the previous display mode.



NOTE: “Network Camera” includes both network cameras and network video transmitters.

When video from network devices is not displayed on the screen, check the current video resolution. The DVR's supported resolutions are 352x240(352x288), 704x240(704x288), 640x480, 704x480(704x576), 800x600, 1280x720, 1280x960, 1280x1024 and 1920x1080.

When monitoring video from network devices in multiview display formats, video at the resolution higher than 704x480 will be displayed 1 image per second.

- **Screen Format:** Selecting  (Display) → Screen Format and choosing the screen mode displays the cameras in the selected multiview screen mode (2x2, 3x2, 3x3, 4x3 or 4x4). Selecting Screen Format while in 4x4 display format for local cameras enters the display mode for network devices, and selecting Screen Format while in 4x4 display format for network devices enters the display mode for local cameras. Selecting each display mode is the same as pressing the **DISPLAY** button or scrolling the mouse wheel up and down when in one of the multiview formats.
- **Previous Group, Next Group:** Selecting  (Display) → Previous Group or Next Group moves to the previous or next page. Selecting Next Group while in 4x4 display format for local cameras moves to 4x4 display format for network devices, and selecting Previous Group while in 4x4 display format for network devices moves to 4x4 display format for local cameras.
- **Edit Group:** Selecting  (Display) → Edit Group enters to the Active Cameo mode. It is the same as pressing the  button in any multiview formats. Refer to the following *Active Cameo Mode* section for details.
- **Camera OSD, Status OSD:** Selecting  (Display) → Camera OSD or Status OSD toggles Camera OSD or Status OSD On and Off.



Freeze

Selecting  (Freeze) in the Live Monitoring menu will freeze the current image on the screen until you select  again. It is the same as pressing the **FREEZE** button. While in the Freeze mode, the icon  displays in bottom-left corner if Freeze is selected in the Display setup screen (OSD tab).



Alarm

Selecting  (Alarm) in the Live Monitoring menu resets the DVR's outputs including the internal buzzer during an alarm. It is the same as pressing the **ALARM** button.

Panic

Selecting  (Panic) in the Live Monitoring menu starts panic recording of all cameras, and selecting  again stops panic recording. It is the same as pressing the **PANIC** button.

Sequence

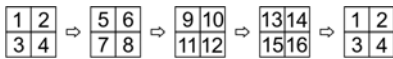

Selecting  (Sequence) in the Live Monitoring menu causes the cameras to display sequentially. It is the same as pressing the **SEQUENCE** button on the remote control. When in one of the multi-view formats, selecting  will cause the DVR to go through predefined screen layouts (Full Sequence). Or, the bottom, right screen will display live cameras sequentially (Cameo Sequence). For example, if you select  in the 2x2 format, the DVR changes pages as follows:



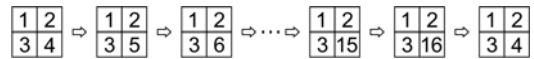

< Full Sequence >







< Cameo Sequence >

NOTE: The sequence display mode between Local Camera and Network Camera repeats. For example, if you select  in the 2x2 format when displaying local cameras 13 to 16 the next screen will be network cameras 1 to 4, and selecting  when displaying network cameras 13 to 16 the next screen will be local cameras 1 to 4.

Selecting  again in the Live Monitoring menu exits the Sequence mode. While in the Sequence mode, the  icon displays in bottom-left corner if Sequence is selected in the Display setup screen (OSD tab). If all the cameras in a page are Off, or have lost video or are set to Covert (unless the user has authority to view covert cameras), that page will be excluded from the sequence.

NOTE: The *Full Sequence* for the full sequence monitoring and the *Cameo Sequence* for the cameo sequence monitoring should be selected in the Display setup screen (Primary Monitor tab).

Camera Menu

- **PTZ:** Selecting  (Camera Menu) → PTZ and choosing the camera number allows you to control the selected camera as long as it has Pan, Tilt and Zoom capabilities. It is the same as pressing the **PTZ** button. Refer to the following *PTZ Mode* section for details.
- **Zoom:** Selecting  (Camera Menu) → Zoom and choosing the camera number zooms the current image of the selected camera on the screen. It is the same as pressing the **ZOOM** button. Selecting Zoom again in the Camera Menu again exits the Zoom mode. Refer to the following *Zoom Mode* section for details.
- **Audio:** Selecting  (Camera Menu) → Audio toggles audio output On and Off.
- **Mic:** Selecting  (Camera Menu) → Mic toggles the DVR's audio that is sent to the network device On and Off.
- **Color Control:** Selecting  (Camera Menu) → Color Control and choosing the camera number allows you to control brightness, contrast, hue and saturation for each camera for the selected camera if a user who has Color Control authority logs into the system. It is the same as pressing and holding a camera button for a few seconds.

NOTE: It is important that cameras and monitors are correctly installed and adjusted prior to making any image adjustments using the DVR's controls.

Any image adjustments you make will be applied to both the live video on the monitors and the recorded video.

The *Camera Menu* also can be displayed by clicking the right mouse button on the screen while in the live monitoring mode.

- **Spot Monitor:** Selecting Spot Monitor allows you to select the camera you want to display on a Spot monitor. Refer to the following *Spot Monitoring* section for details.



Search

Selecting  (Search) in the Live Monitoring menu exits the live monitoring mode and enters the search mode. It is the same as pressing the **Search/Stop** button.

Setup

Selecting  (Setup) in the Live Monitoring menu enters the Main Setup screen. Refer to *Chapter 3 – Configuration* for detailed descriptions of system setup.





Active Cameo Mode

You can enter the Active Cameo mode by selecting **Edit Group** from the Live Monitoring – Display menu or pressing the  button on the front panel in any multi-view format. The yellow outline surrounding the video indicates the active cameo, and pressing the arrow buttons moves the active cameo. Pressing the  button exits the Active Cameo mode. Selecting **Exit Group Edit** in the cameo menu displayed when pressing the  button also exits the Active Cameo mode. The active cameo mode will remain in effect for 15 seconds if there is no further operation.

In active cameo mode, press the button for the camera you want to display in the active cameo. After setting the camera number to active cameo, the DVR moves the active cameo to the next cameo. When the camera number exists on the current screen, the active cameo is changed with the existing camera number. When the camera number does not exist on the current screen, the active cameo is replaced by the camera number. You can change the screen layout in this way.

NOTE: Editing a camera group of both local cameras and network devices in one monitor is not supported.

Zoom Mode

You can enlarge an area of the video by pressing the  button. For a few seconds after pressing the  button, a rectangle displays on the screen. A rectangle shows the area that will be enlarged. You can move the rectangle around using the arrow buttons. Pressing the  button or turning the Jog Dial counterclockwise in the Zoom mode toggles the zoom size between 2x, 3x and 4x. Exit the Zoom mode by pressing the  button. While in the Zoom mode, the icon  displays if Zoom is selected in the Display setup screen (OSD tab).





NOTE: Entering the zoom mode is NOT supported while in the SD display mode.

PTZ Mode

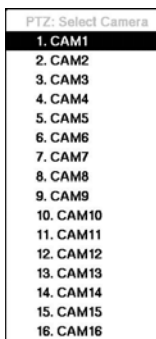
If a user who has PTZ Control authority logs into the system, the user can control PTZ cameras. The DVR will control cameras with Pan, Tilt and Zoom capabilities. Press and hold the  button to display the PTZ camera menu and enter the PTZ mode, and press the button again to exit the PTZ mode.

Select the PTZ camera you wish to control by selecting it from the menu. The icon  displays on the PTZ camera screen.



To use the front panel buttons, press the **Left** and **Right** arrow buttons to pan left and right. Press the **Up** and **Down** arrow buttons to tilt the camera up and down. Press the  button to zoom in, and press the  button to zoom out. You can use the  and  buttons to focus the image.

You can establish preset positions for PTZ cameras. Press the  to establish Presets.

You can quickly move PTZ cameras to Preset positions. Press the  to view an established camera Preset position.

Figure 45 : PTZ Select Camera menu.



You can save camera position settings as “presets” so that you can go directly to desired views.

Once you have the camera at the desired settings, press the button, and the Set Preset dialog box will appear. Select the number you want to assign to the preset and press the button. Use the virtual keyboard to enter the preset name.

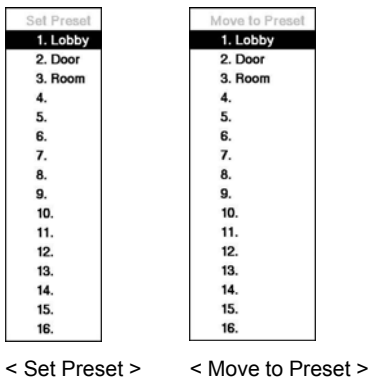
Press the button to load the PTZ preset and the Move to Preset dialog box will appear. Select the desired preset and press the button to load the preset.

Figure 46 : PTZ Preset menu.

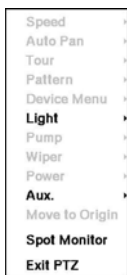

While in the PTZ mode, pressing the **MENU** button and selecting (Advanced PTZ) in the menu displaying at the top of the screen displays the Advanced PTZ menu.

Set the feature you wish to control by selecting it from the menu. Refer to the camera manufacturer’s instructions for the proper settings. Depending on the camera specifications, some features may not be supported.

You can use a mouse for convenient PTZ control. Click the left mouse button on the image and move that image in the direction you want to by dragging the mouse. Use the mouse wheel to zoom in and out. Position the mouse pointer at the bottom of the screen, and the following PTZ toolbar will display.

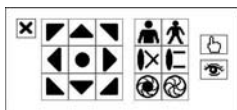

Clicking on the left side exits the toolbar. If you want to display the toolbar again, position the mouse pointer at the bottom of the screen. Change the toolbar location by clicking the empty space on the left side of the toolbar and drag it to where you want it located on the screen. Use the arrow buttons on the toolbar to pan or tilt the camera in the direction you want. The other controls on the toolbar perform as described below:

- Zoom In / Out
- Focus Near / Far
- Iris Open / Close
- Set / Load Preset
- Advanced PTZ

Event Monitoring

When an event occurs, the DVR will display the camera associated with the event and the icon displays on screen if Event Monitoring is set in the Display setup screen (Primary Monitor tab). Setting Event Monitoring to Local Camera displays the local cameras associated with the event, and setting it to Network Cameras displays the network cameras associated with the event.

NOTE: Displaying cameras associated with the event from both local cameras and network devices at the same time is not supported. The camera mode between Local Camera and Network Camera can be selected in the Display – Primary Monitor setup.

How the cameras are displayed depends on the number of cameras associated with the event. If one camera is associated with the event, the DVR will display the camera full screen. If two to four cameras are associated with the event, the DVR will display the cameras on a 2x2 screen. If five to nine cameras are associated with the event, the DVR will display the cameras on a 3x2 or 3x3 screen. If 10 or more cameras are associated with the event, the DVR will display the cameras on a 4x3 or 4x4 screen.

Event monitoring lasts for the dwell time set for event recording. After the dwell time has elapsed, the monitor returns to the previous screen unless another event has occurred. If you want to return to the live monitoring mode before the dwell time has elapsed, press the **DISPLAY** button or one of the camera buttons.

Covert Camera

If a camera is set up as **Covert 1** in the Camera setup screen (General tab), that camera will not be displayed unless a user with **Covert Camera View** authority logs into the system. However the camera title and status icons will be displayed on the monitor.

If a camera is set up as **Covert 2** in the Camera setup screen (General tab), that camera appears to be Off unless a user with **Covert Camera View** authority logs into the system. The camera title will be grayed out and status icons will not be displayed on the monitor.

NOTE: When a camera is set up as Covert 1, the DVR displays the camera title and status icons on the covert video. When set up as Covert 2, the DVR displays only the camera title on the covert video.

If a user who has **Covert Camera View** authority logs into the system, the user can view video from cameras set to **Covert 1** or **Covert 2** including the camera titles and status icons.



NOTE: The covert camera function of network devices follows the settings you set in the network device not in the DVR.

Spot Monitoring

NOTE: Spot monitoring video from network devices will not be supported.

The multiview screen display (2x2 or 4x4) and sequence monitoring is supported on a Spot Monitor. Selecting **Spot** after pressing the **MONITOR** button or selecting  (Monitor) in the Live Monitoring menu allows you to control a Spot Monitor.

Select  (Display) → **Screen Format** in the Live Monitoring menu and then select the screen mode between 2x2 and 4x4 you want to display on a Spot Monitor.

Selecting  (Sequence) in the Live Monitoring menu causes the cameras to display sequentially, and selecting  again stops sequencing on a Spot Monitor. Any cameras that are Off, have lost video or are set to **Covert** (unless the user has authority to view covert cameras) will be excluded from the sequence. When the Spot Monitor is in the sequence mode, you can set the camera's display dwell time. Refer to *Chapter 3 – Configuration – Display Setup* section for details.

NOTE: Sequence cannot be used in the 4x4 display mode.

Recording Video

Once you have installed the DVR following the instructions in *Chapter 2 – Installation*, it is ready to record. The DVR will start recording based on the settings you made in the Record setup screen. See *Chapter 3 – Configuration*.

Recycle On or Recycle Off. The factory default is **Recycle On**. It does this by recording over the oldest video once the hard disk is full. Setting the DVR to **Recycle Off** causes it to stop recording once the hard disk is full.

NOTE: When recording video from network devices, the DVR has a recording speed of 70 ips with Standard image quality and a resolution setting of 1920x1080 for each channel. Depending on the DVR's operating situation and network environment, the recording speed of network devices might increase or decrease. This recording speed standard is based on 1-Gbps Ethernet when the DVR is only recording video from network devices, and the monitoring feature is not being used.

The recording speed (ips) and resolution for the network camera will follow the settings you set in the camera and not the settings in the DVR.

When the recording speed and resolution for the network video transmitter you set in the DVR are higher than the ones you set in the network video transmitter, the DVR will record video at the recording speed and resolution you set in the network video transmitter.

Although you will be able to record without changing the unit from its original factory settings, you will want to take advantages of the DVR's many tools. See *Chapter 3 — Configuration* for detailed descriptions of the recording mode options.

Panic Recording

Selecting **[!]** (Panic) in the Live Monitoring menu or Search menu, or pressing the **[PANIC]** button starts panic recording of all cameras. Selecting **[!]** or pressing the button again stops panic recording. If you set the Panic Recording Duration in the Panic Record setup screen, panic recording will stop automatically according to the preset duration as long as **[!]** is not selected or the **[PANIC]** button is not pressed.

NOTE: When the DVR is not in the Recycle mode and all available storage space has been used, panic recording will not operate.

Recording Audio

If the DVR was set up to record audio, it will record audio from up to 16 inputs when video is recording.

NOTE: Make certain you comply with all local and federal laws and regulations when recording audio.

Playing Recorded Video

NOTE: Playing recorded video from both local cameras and network devices at the same time is not supported. Playback mode for Local Camera and Network Camera can be selected in the Search menu. Refer to the following *Searching Video* section for details.

When playing video from network devices in the multiview display formats, video at 1280x760 or higher resolution will be displayed 1 image per second.

If a user who has Search authority logs into the system, the user can view recorded image. Once video has been recorded, you can view it by pressing the **[▶/⏸]** (Play/Pause) button.

The DVR supports the Triplex function: monitoring, recording and playing back at the same time. (Local Cameras Only) Pressing the **[F3]** (Search/Stop) button when in one of the multi-view formats enters the Triplex mode and displays the Select Playback Camera menu.

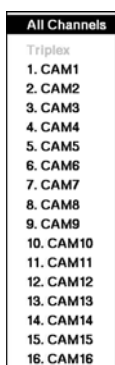

Selecting All Channels plays back video of all cameras. The DVR maintains the same display format as it does in the live mode. You can also change the screen layout in the same way as you do in the live mode.

Selecting the camera number under Triplex enters the Triplex mode and plays back video of the selected camera. When in the single-screen display format, the camera currently displayed on the screen will be selected for the search channel. During the Triplex mode, the DVR maintains the same display format as it does in the live mode. A red outline surrounding the video and the camera title indicates the search channel. While in the Triplex Mode, the DVR continues recording cameras as they were set up in the recording schedule. Also, live monitoring will continue except for the camera that has been selected for playback.

Figure 47 : Select Playback Camera menu.

When playing video for the first time, the DVR will display the most recent image. When playing video subsequent times, the DVR will start playing video from the last recalled image. Recorded audio will be played when the DVR displays a camera with recorded audio in full screen mode.

NOTE: Only the administrator and users with *Covert Camera View* authority can view video from covert cameras. The covert cameras in the playback mode are determined by the current camera settings.

Camera Buttons (1 to 16): Pressing the individual camera buttons will cause the selected camera to display full screen.

Playback Buttons

- **Backward:** When in the pause mode, pressing the [◀] button moves to the previous image.
- **Forward:** When in the pause mode, pressing the [▶] button moves to the next image.
- **Rewind:** Pressing the [⏮] button plays video backward at high speed. Pressing the button again toggles the playback speed from [⏮], [⏮⏮] and [⏮⏮⏮].
- **Play/Pause:** Pressing the [⏸] button plays back video at regular speed. The screen displays || when the DVR is in the Pause mode and the screen displays ▶ when the DVR is playing back video.
- **Fast Forward:** Pressing the [⏭] button plays video forward at high speed. Pressing the button again toggles the playback speed from [⏭], [⏭⏭] and [⏭⏭⏭].
- **Search/Stop:** Pressing the [🔍] button while in the Live Monitoring mode enters the Search mode. Pressing the [🔍] button while in the Search mode returns the DVR to the Live Monitoring mode.

Jog Dial, Shuttle Ring

- **Jog Dial:** The Jog Dial only functions when playback video has been paused. By turning the jog dial clockwise, you can play video forward image-by-image. By turning the jog dial counterclockwise, you play video backward image-by-image.
- **Shuttle Ring:** The Shuttle Ring only functions in the Playback mode. The Shuttle Ring is spring loaded and returns to the center position when released. Turning the ring clockwise plays video forward. Turning the ring counterclockwise plays video backward. Playback speed varies with the amount the ring is turned. The playback speeds are [⏮], [⏮⏮], [⏮⏮⏮], [▶x0.5], [▶], [▶▶], [▶▶▶] and [▶▶▶▶]. When you release the ring, it snaps back to the center position and the video pauses.

ZOOM Button: Pressing the [ZOOM] button zooms in the current image on the screen.

DISPLAY Button: Pressing the [DISPLAY] button toggles different display formats. The available formats are: 2x2, 3x2, 3x3, 4x3 and 4x4.

You can use a mouse for convenient playback control. Position the mouse pointer on the playback screen, and the following Record Table Search (Compact View Mode) screen will display. The individual controls on the toolbar perform the following functions as described below:



- | | | |
|------------------------------|-----------------------|--------------------------|
| [◀] Go to the previous image | [⏸] Play/Pause | [▶] Go to the next image |
| [⏮] Fast backward play | [⏭] Fast forward play | |

Searching Video

While in the search mode, pressing the [MENU] button displays the following Search menu on the right edge of the screen. Pressing the [MENU] button again hides the menu. You can navigate through menus and items by pressing the arrow buttons.







Figure 48 : Search menu.



NOTE: The Search menu also can be displayed by moving the mouse pointer to the right edge of the screen.

Search Menu



Search

- **Event Log Search:** Selecting  (Search) → Event Log Search selects video from the event log. See the following *Event Log Search* section for details.
- **Record Table Search:** Selecting  (Search) → Record Table Search selects using a recording table. See the following *Record Table Search* section for details.
- **Motion Search:** Selecting  (Search) → Motion Search selects motion events. See the following *Motion Search* section for details.
- **Text-In Search:** Selecting  (Search) → Text-In Search selects text input strings. See the following *Text-In Search* section for details.

Go To

- **Go to the First:** Selecting  (Go To) → Go to the First displays the first recorded image.
- **Go to the Last:** Selecting  (Go To) → Go to the Last displays the last recorded image.
- **Go to the Date/Time:** Selecting  (Go To) → Go to the Date/Time displays the Go to the Date/Time screen.

Move the cursor over the date and time and press the  button. You can use the Left and Right arrow buttons to highlight the year, month, day, hours, minutes and seconds. Use the Up and Down arrow buttons to change to the date and time you want to search for video.

Once you have set the date and time you want, press the  button. Then highlight **Go** and press the  button. The selected date and time will display. (If no video was recorded during the selected time, a message appears alerting you that no image was recorded at that time.) The playback buttons, Jog and Shuttle can now be used to review the surrounding video.







- **Bookmark:** Selecting  (Go To) → Bookmark adds the current playback point to the bookmark list. See the following *Bookmarks* section for details.

Display



- **Local Camera:** Selecting  (Display) → Local Camera and choosing the camera number displays the selected local camera full screen. It is the same as pressing the individual camera buttons on the front panel or clicking the left mouse button on a camera image when in one of the multiview formats (i.e., 2x2, 3x2, 3x3, 4x3 or 4x4). Clicking the left mouse button on the screen again returns to the previous display mode.

- **Network Camera:** Selecting  (Display) → Network Camera and choosing the camera number displays the selected network camera full screen. It is the same as pressing the individual camera buttons on the front panel or clicking the left mouse button on a camera image when in one of the multiview formats (i.e., 2x2, 3x2, 3x3, 4x3 or 4x4). Clicking the left mouse button on the screen again returns to the previous display mode.



NOTE: “Network Camera” includes both network cameras and network video transmitters.

- **Screen Format:** Selecting  (Display) → Screen Format and choosing the screen mode displays the cameras in the selected multiview screen mode (2x2, 3x2, 3x3, 4x3 or 4x4). Selecting Screen Format while in 4x4 display format for local cameras enters the display mode for network devices, and selecting Screen Format while in 4x4 display format for network devices enters the display mode for local cameras. Selecting each display mode is the same as pressing the  button or scrolling the mouse wheel up and down when in one of the multiview formats.
- **Previous Group, Next Group:** Selecting  (Display) → Previous Group or Next Group moves to the previous or next page. Selecting Next Group while in 4x4 display format for local cameras moves to 4x4 display format for network devices, and selecting Previous Group while in 4x4 display format for network devices moves to 4x4 display format for local cameras.
- **Edit Group:** Selecting  (Display) → Edit Group enters to the Active Cameo mode. It is the same as pressing the  button in any multiview formats. Refer to the previous *Live Monitoring – Active Cameo Mode* section for details.
- **Camera OSD, Status OSD:** Selecting  (Display) → Camera OSD or Status OSD toggles Camera OSD or Status OSD On and Off.



Alarm

Selecting  (Alarm) in the Search menu resets the DVR's outputs including the internal buzzer during an alarm. It is the same as pressing the  button.



Panic

Selecting  (Panic) in the Search menu starts panic recording of all cameras, and selecting  again stops panic recording. It is the same as pressing the  button.

Camera Menu

- **Zoom:** Selecting  (Camera Menu) → Zoom and choosing the camera number zooms the current playback image of the selected camera on the screen. It is the same as pressing the  button. Selecting ZOOM again exits the Zoom mode.





NOTE: Entering the zoom mode is NOT supported while in the SD display mode.

- **Audio:** Selecting  (Camera Menu) → Audio toggles audio playback On and Off. Recorded audio will be played when the DVR displays a camera with recorded audio in full screen mode.
- **Show/Hide Text-In:** Selecting  (Camera Menu) → Show Text-In or Hide Text-In shows or hides the text-in data on the screen if the video was recorded with text-in data.

NOTE: The *Camera Menu* also can be displayed by clicking the right mouse button on the screen while in the search mode.

- **Spot Monitor:** Selecting Spot Monitor allows you to select the camera you want to display on a Spot monitor. Refer to the previous *Live Monitoring – Spot Monitoring* section for details.

Export

- **A–B Clip-Copy:** Selecting  (Export) → A–B Clip-Copy will set the starting point of the video to be clip copied, and the  icon displays at the bottom-left corner of the screen. Selecting A–B Clip-Copy again will set the ending point of the video to be clip copied and displays the Clip-Copy screen. See the following *Clip Copy* section for details.
- **Clip-Copy:** Select  (Export) → Clip-Copy, and the Clip-Copy screen appears to allow clip copy setup. See the following *Clip Copy* section for details.
- **Print:** Selecting  (Export) → Print allows you to print a selected image. See the following *Print* section for details.

Data Source

Selecting  (Data Source) in the Search menu allows you to select the data source to be searched. Selecting **Record** searches recorded data on primary storage installed in the DVR, and selecting **Archive** searches archived data on secondary storage installed in the DVR.

Exit

Selecting  (Exit) in the Search menu exits the search mode and enters the live monitoring mode.

Event Log Search

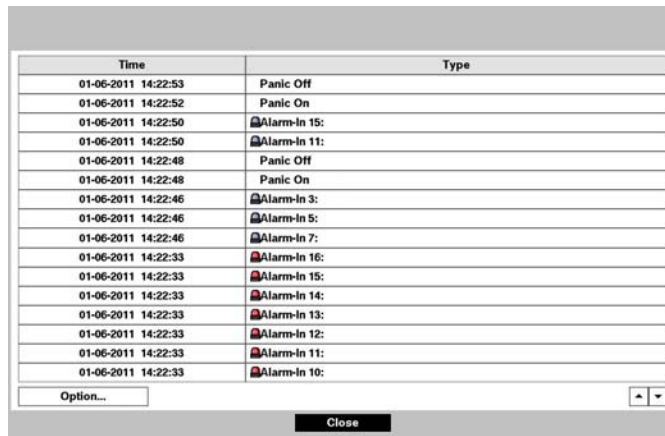



Time	Type
01-06-2011 14:22:53	Panic Off
01-06-2011 14:22:52	Panic On
01-06-2011 14:22:50	Alarm-In 15:
01-06-2011 14:22:50	Alarm-In 11:
01-06-2011 14:22:48	Panic Off
01-06-2011 14:22:48	Panic On
01-06-2011 14:22:46	Alarm-In 3:
01-06-2011 14:22:46	Alarm-In 5:
01-06-2011 14:22:46	Alarm-In 7:
01-06-2011 14:22:33	Alarm-In 16:
01-06-2011 14:22:33	Alarm-In 15:
01-06-2011 14:22:33	Alarm-In 14:
01-06-2011 14:22:33	Alarm-In 13:
01-06-2011 14:22:33	Alarm-In 12:
01-06-2011 14:22:33	Alarm-In 11:
01-06-2011 14:22:33	Alarm-In 10:

Figure 49 : Event Log Search screen.

The DVR maintains a log of each time the Alarm Input port is activated. The **Event Log Search** screen displays this list. Use the arrow buttons to highlight the event for which you would like to see video.

The Event Log Search screen can also be accessed by pressing the **ALARM** button unless there is an alarm. There is no determined user authority to display the Event Log Search screen, however, the event video will not be played unless a user with **Search** authority logs into the system.

Pressing the  button will extract the event video and display the first image of the event. Pressing the  (Play/Pause) button will start playing the “event” video segment. Pressing  (Search/Stop) returns to live monitoring.

NOTE: It is possible that no recorded image displays on the current screen. Press the **DISPLAY** button and change the screen mode to 4x4. You will be able to easily see the camera have recorded video during target time.

You can also narrow your event search by selecting the **Option...** button and setting up the new search condition.



Event Log Search Option

From First 2012/04/20 11:11:28

To Last 2012/04/20 11:11:28

Check Time Overlap

Alarm-In 1-32 Panic Record

Motion 1-32 Check Recording

Video Loss 1-32 Check Alarm-In

Video Blind 1-32 Disk Almost Full

Audio Detection 17-32 Disk Bad

Trip-Zone 17-32 Disk Temperature

Tampering 17-32 Disk S.M.A.R.T.

Text-In 1-16 Fan Error

Record Channels 1-32 eSATA/iSCSI Disconnected

Search Cancel

You can search video from the first to last recorded images, or you can set the start and stop times and dates.

Highlight the box beside **FROM** and press the  button to toggle between On and Off. When set to Off, you can enter a specific Date and Time. When set to On, the search will be from the first recorded image.

Highlight the box beside **TO** and press the  button to toggle between On and Off. When set to Off, you can enter a specific Date and Time. When set to On, the search will be from the last recorded image.

Highlight the box beside **Check Time Overlap** and press the  button. It toggles between On and Off. You will only be able to turn the Check Time Overlap on or off if a user-defined date and time is set to From and To. If the DVR's date and time have been reset, it is possible for the DVR to have more than one overlapping start and stop time. When set to On, you will be asked to select one of the overlapping start and stop time. When set to Off, the DVR will display search results from all start times to all stop times.

Highlight the box beside **Alarm-In** and press the  button. You can select the alarm inputs that you want to include in your search.

Highlight the box beside **Motion** and press the  button. You can select the cameras for which you want any reports of motion detection.

Highlight the box beside **Video Loss** and press the  button. You can select the cameras for which you want any reports of lost video.

Highlight the box beside **Video Blind** and press the  button. You can select the cameras for which you want any reports of blind video.

Highlight the box beside **Audio Detection** and press the  button. You can select the cameras for which you want any reports of audio input. (Network Devices Only)

Highlight the box beside **Trip-Zone** and press the  button. You can select the cameras for which you want any reports of trip-zone. (Network Devices Only)

Highlight the box beside **Tampering** and press the  button. You can select the cameras for which you want any reports of tampering. (Network Devices Only)

Highlight the box beside **Text-In** and press the  button. You can select the text-in devices which you want any reports of text input.

Highlight the box beside **Record Channels** and press the  button. You can select the cameras that you want to search for any reports of event recorded data. The DVR will display the events (not the camera channels) that occurred and that also are recorded on the camera channel that you selected. If you do not select a camera channel in this field, the DVR will search events that are not associated with cameras.

You can also toggle On and Off self-diagnostic System Events as part of your search. The choices are:

- Panic Record
- Check Recording
- Check Alarm-In
- Disk Almost Full
- Disk Bad
- Disk Temperature
- Disk S.M.A.R.T.
- Fan Error
- eSATA/iSCSI Disconnected

Once you set your desired search conditions, highlight **Search** and press the  button to display the search results in the **Event Log Search** screen. Selecting **Cancel** exits the screen without saving the changes.

Record Table Search

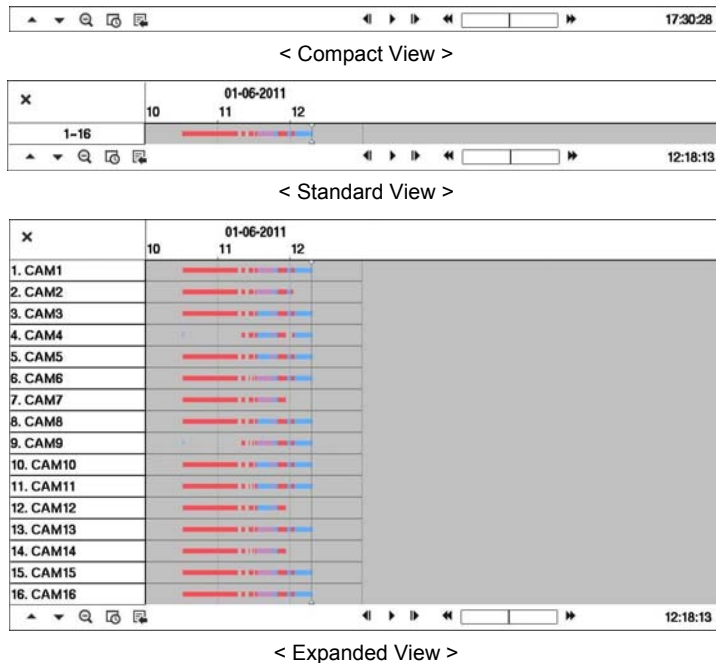

Figure 50 : Record Table Search screen.

Recording information about video images currently displayed on the screen displays on the recording status bar. A grey vertical line indicates the current search position. To search specific video, move the vertical line by using the Left or Right arrow buttons on the front panel or by clicking the mouse on the desired segment.

If the DVR's time and date have been reset to a time that is earlier than some recorded video, it is possible for the DVR to have more than one video stream in the same time range. In this case, the overlapping time range in the record table will be separated by a yellow vertical line.

NOTE: The recorded data in the time range located after the white vertical line is the latest.

There are three view modes. Standard view, Expanded view and Compact view. Standard view (default) displays combined recording information of all camera channels currently displayed on the screen. In the Standard view mode, selecting the ▲ icon located at the bottom switches to the Expanded view mode. The Expanded view displays the recording information of each camera channel currently displayed on the screen. Selecting the ▼ icon in the Standard view mode switches to the Compact view mode which displays only the toolbar. Selecting the ▲ icon in the Compact view mode switches to the Standard view mode, and selecting the ▼ icon in the Expanded view mode switches to the Standard view mode.

Selecting 🔍 or 🔍 located at the bottom zooms the record table. Selecting 🔍 displays eight hours (1-minute based), and selecting 🔍 displays 24 hours (3-minute based) at once. To move to earlier or later times that are not shown in the current record table screen, select the arrows located at the end of the times by using the arrow buttons on the front panel.

NOTE: If the DVR has images recorded in more than one recording mode in the same time range, the recording status bar displays recording information in the following priority order: Panic → Pre-Event → Event → Time → Irregular (Irregular recording caused by temporary disconnection from the network device). The color of the bar indicates different recording modes: Red for Panic, Yellow for Pre-Event, Purple for Event, Blue for Time, and Green for Irregular.

Selecting 📅 located at the bottom displays the Calendar Search screen.



Days with recorded video display on the calendar with white numbers. You can highlight the days with recorded video by using the arrow buttons. Once you have highlighted a day, press the button to select it. The first recorded image of the selected date will pause on the screen. Once you have selected the date you want to search, review the surrounding video by using the playback controls located at the bottom of the Record Table Search screen.

Selecting located at the bottom displays the Search menu.

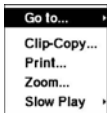

- **Go To:** Displays the first or last recorded image, searches by date and time, or adds the current playback point to the bookmark list (see the previous *Searching Video – Go To* and *Bookmarks* sections of this chapter for more details).
- **Clip-Copy:** Clips a video segment and saves it (see the following *Clip Copy* section for more details).
- **Print:** Prints the current playback image.
- **Zoom:** Zooms the current playback image.
- **Slow Play:** Plays video at low speed (x1/2, x1/3, x1/4, x1/6 and x1/8).

The individual playback controls at the bottom perform the following functions as described below:

- Go to the previous image
- Play/Pause
- Go to the next image
- Fast backward play
- Fast forward play

Selecting in the top-left corner exits the Record Table Search screen.

Motion Search

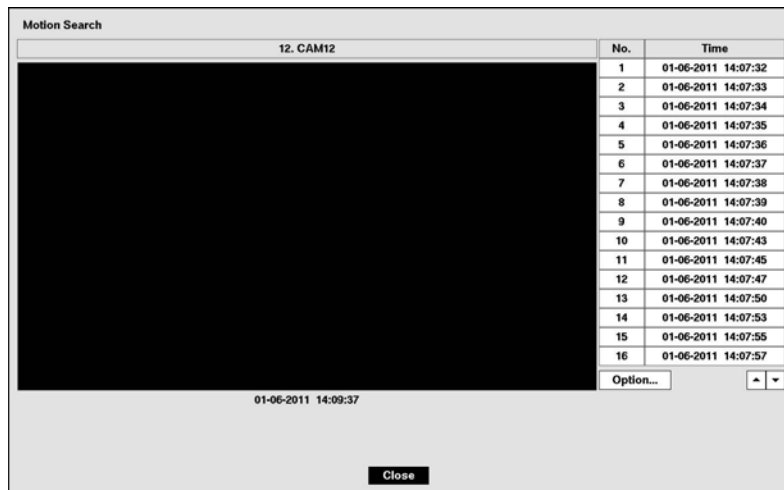

Figure 51 : Motion Search screen.

The Motion Search... can be selected from the Search menu while the DVR displays the camera full screen. The Motion Search screen displays a list of motion events. Use the arrow buttons to highlight the event for which you would like to see video and press the button to display the video associated with the selected event on the small search screen.

Highlighting Close and pressing the button will extract the video associated with the Motion event and display the first image of the event. Pressing the (Play/Pause) button will start playing the “event” video segment. Pressing (Search/Stop) returns to live monitoring.

You can also narrow your event search by selecting the Option... button and setting up the new search condition.

You can search video from the first to last recorded images, or you can set the start and stop times and dates.

Highlight the box beside **From** and press the button to toggle between On and Off. When set to Off, you can enter a specific Date and Time. When set to On, the search will be from the first recorded image.

Highlight the box beside **To** and press the button to toggle between On and Off. When set to Off, you can enter a specific Date and Time. When set to On, the search will be from the last recorded image.

Highlight the box beside **Type** and press the button. You can select between **Motion Search** and **Museum Search**. **Motion Search** detects motion in the defined area. **Museum Search** detects if a defined object has moved.

Highlight the box beside **Zone** and press the button. An image from the video appears with a grid overlaid. You can turn sensor blocks On and Off to define the area of the picture in which you want to search for motion.

NOTE: Defining the area of the image in which you want to search for motion is nearly identical to setting up the DVR for Motion Detection. Please refer to *Motion Setup Screen* in *Chapter 3 — Configuration* for more detailed instructions on setting up the detection blocks.

When setting the Museum Search Zone, the zone should be placed inside of the border line of the target object. If the selected block is placed on the border line, the sensitivity of the Museum Search may decrease.

The zone should be placed or focused on the centre or, at least, within the outline of targeted object.

Highlight the box beside **Sensitivity** and press the button. You will be able to select from 1 (low sensitivity) to 5 (high sensitivity).

Highlight the box beside **Min. Blocks** and press the button. You will be able to set the number of sensor blocks that must be activated. Setting the Min Blocks will only be available if Motion Search is selected.

Once you set your desired search conditions, highlight **Search** and press the button to display the search results in the **Motion Search** screen. Selecting **Cancel** exits the screen without saving the changes.

When you search for motion events of another camera, you will be asked whether or not you want to delete the previous search results from the list.

Text-In Search

Time	Transaction				
01-06-2011 12:40:44	Item	Unit price	Qty	amount	// 12:40:4
01-06-2011 12:40:01	Item	Unit price	Qty	amount	// 12:40:0
01-06-2011 12:40:00	Garlic bread \$	1.15	1(s) \$	1.15	// 12:40:0
01-06-2011 12:21:22	Garlic bread \$	1.15	1(s) \$	1.15	// 12:21:2
01-06-2011 12:20:42	// 12:20:42 19659				
01-06-2011 12:14:24	t // 12:14:24 19658				
01-06-2011 12:10:44	= t // 12:10:44 19657				
01-06-2011 11:26:14	abc Market		2003.01.01	AM 09:00	// 11:26:1
01-06-2011 11:24:42	Pan cake \$	3.15	1(s) \$	3.15	// 11:24:4
01-06-2011 11:22:10	Pan cake \$	3.15	1(s) \$	3.15	// 11:22:1

Option...
None

Close

Figure 52 : Text-In Search screen.

The DVR maintains a log of each time there is Text Input. The **Text-In Search** screen displays this list. Use the arrow buttons to highlight the event for which you would like to see video.

Pressing the button will extract the video associated with the Text Input and display the first image of the event. Pressing the (Play/Pause) button will start playing the “event” video segment. Pressing (Search/Stop) returns to live monitoring.

NOTE: It is possible that no recorded image displays on the current screen. Press the **DISPLAY** button and change the screen mode to 4x4. You will be able to easily see the camera have recorded video during target time. **Text Input information will be overlaid on the image while the recorded video is played at regular speed.**

You can also narrow your event search by selecting the Option... button and setting up the new search condition.

Text-In Search Option

From First 01-06-2011 14:28:30

To Last 01-06-2011 14:28:30

Channels 1-14

Generic Text

No.	Name	Comp.	Value	Column	Line	X
				0	0	X
				0	0	X
				0	0	X
				0	0	X
				0	0	X

+
 Case Sensitive

Load Save
Search Cancel

You can search video from the first to last recorded images, or you can set the start and stop times and dates.

Highlight the box beside **From** and press the button to toggle between On and Off. When set to Off, you can enter a specific Date and Time. When set to On, the search will be from the first recorded image.

Highlight the box beside **To** and press the button to toggle between On and Off. When set to Off, you can enter a specific Date and Time. When set to On, the search will be from the last recorded image.

Highlight the **Channel** and press the button. Select the text-in devices that you want to search for text input.

Highlight the **Text Input Device** box and press the  button. Select your Text Input Device from the list.

Highlighting the **+** and pressing the  button allows you to add a new set of search parameter. Set up the desired search parameter. Refer to the *Appendix – Text-In Search Examples* for further information on setting up search parameters. The **X** column can be used to delete a set of search parameter or entire sets of search parameters.

Highlight **Case Sensitive** and press the  button. This will toggle between On and Off. When this feature is On, the search will find only those text strings in which the case matches.

Highlight **Load** and press the  button to load saved search option settings. Select the desired search option settings.

Highlight **Save** and press the  button to save the current search option settings. A virtual keyboard appears that you can use to enter the search option name.

Once you set your desired search conditions, highlight **Search** and press the  button to display the search results in the **Text-In Search** screen. Selecting **Cancel** exits the screen without saving the changes.

Bookmarks

The **Bookmarks** screen can also be accessed by pressing the **BOOKMARK** button when in playback mode.

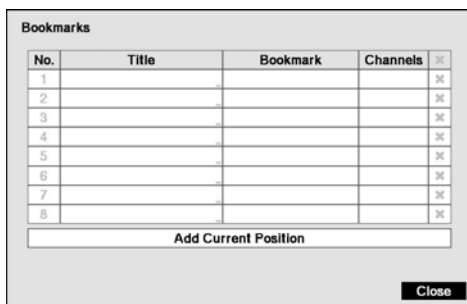

Highlight the **Add Current Position** box and press the  button to add the current playback point to the bookmark list. Highlight the **Title** box and enter the name of the registered bookmark. Use the virtual keyboard to enter the bookmark name.

NOTE: Up to eight bookmarks can be registered.

Use the arrow buttons to highlight the bookmark point for which you would like to see video. The selected bookmark will display on the screen. The playback buttons, Jog and Shuttle can now be used to review the surrounding video.

Figure 53 : Bookmarks screen.

Clip-Copy

Video clips can be copied on an internal DVD RW drive, or external USB hard disk or flash drive. The copied video clips can be viewed on computers running Microsoft Windows 2000, XP, Vista or 7. Refer to the *Appendix – USB Hard Disk Drive Preparation* for information on preparing the external drive for clip copy.

Selecting **A–B Clip-Copy** in the **Search – Export** menu or pressing the **CLIP COPY** button on the remote control during playback will set the starting point of the video to be clip copied, and the  icon displays at the bottom-left corner of the screen. Selecting **A–B Clip-Copy** in the **Search – Export** menu or pressing the **CLIP COPY** button on the remote control again will set the ending point of the video to be clip copied by displaying the **Clip-Copy** screen.

Pressing and holding the **MENU** button on the front panel or the **CLIP COPY** button on the remote control for more than three seconds while in the **Search** mode initiates the **One-Touch Clip Copy** function. The last recorded image will be the ending point of video to be clip copied, and the system will automatically begin to calculate the possible video data size that the selected storage media can handle.

Select **Clip-Copy** in the **Search – Export** menu, and the **Clip-Copy** screen appears to allow clip copy setup.

Figure 54 : Clip-Copy screen.

The **Data Source** box displays the source from which you make a video clip copy. The data source can be selected from **Record** or **Archive** in the **Search** menu.

Highlight the box beside **From** and press the button to set a starting Date and Time. When highlighting and pressing the button the bookmark list displays and the bookmark point you selected will be the starting date and time.

Highlight the box beside **To** and press the button to set an ending Date and Time. When highlighting and pressing the button the bookmark list displays and the bookmark point you selected will be the ending date and time.

Highlight the box beside **Channels** and press the button. You can select the cameras that you would like to include in your video clip.

Highlight the box beside **Channels** and press the button. You can select the cameras that you would like to include in your video clip.

NOTE: The channel numbers 1 to 16 are local camera channels and 17 to 32 are network device channels.

Highlight the box beside **Password** and press the button. A virtual keyboard appears allowing you to enter the password for reviewing the video clips.

Highlight the box beside **Dest.** and press the button. You can select the storage device on which you would like to record the video clip. You can choose from **Internal DVD RW** and **USB Storage**.

CAUTION: The USB device for clip copy must be FAT 16 or FAT32 format.

NOTE: While copying video clips on the DVD RW, the recording speed might decrease.

When the error message “Firmware update of the optical drive is required” displays, update the firmware of the installed DVD RW drive. Please follow the instructions described in *Chapter 3 – Configuration – System Setup* section.

The DVR automatically assigns a file name to the video clip. However, you can give the video clip file a different name. Highlight the box beside **File Name** and press the button. A virtual keyboard appears. Enter a file name for the video you are backing up and select **Close**. The DVR will automatically add the camera number (for example “01”) and “.exe” to the file name.



NOTE: When naming a file, you cannot use the following characters: \, /, :, ;, *, ?, !, “, <, >, |.

Highlight **Include Text-In Data** and press the button. This will toggle between **On** and **Off**. When this feature is **On**, you can include text-in data when copying video if the video was recorded with text-in data.

Highlight **Verify After Burning** and press the button. This will toggle between **On** and **Off**. When this feature is **On**, you can verify that the data is written on the DVD RW properly.

Highlight **Use Site Info** and press the button. This will toggle between **On** and **Off**. When this feature is **On**, you can add the site name to the file name for the video you are backing up.

NOTE: When the site name is added to the file name, some special characters (\, /, :, ;, *, ? , !, “, <, >, |) in the site name will be converted to “_”.

Once you have given the video clip a file name, highlight the Start button and press the  button. The confirmation screen displaying data size will appear. When the storage device does not have enough space, the DVR will ask if you want to copy as much of the video clip as possible in the available space. Highlight the Continue button and press the  button to continue clip copy.

Once the clip copy starts, you can cancel it by selecting Cancel or hide the screen by selecting Close. When selecting Close, Clip Copy continues and a confirmation screen will display when complete.

NOTE: Only 4.7GB DVD media is available. To clip copy video on DVD media using remaining space, the size of previously recorded data on the DVD media should be less than 4GB.

Select the Full Erase option when erasing recorded data on DVD media, otherwise the media will not operate properly when rewritten.

The file size for clip copy is limited to 30GB. When copying video clips larger than 2GB, the video clips will be save in units of 2GB. For example, 3 individual 2GB files will be created when saving a 6GB video clip. However, the file size for the One-Touch Clip Copy is limited to 2GB.

You can use other functions on the DVR while video is being backed up. To do this, highlight the Close button and press the  button. You can return to the Clip-Copy screen at any time to check the progress.

You do not need to install any special software on your personal computer to review the video clips. Refer to ATVision manual for instructions on how to review video clips you have copied.

NOTE: During Clip Copy, you cannot shut the system down, clear data on the storage device, or format the storage device.

CAUTION: Do NOT disconnect the USB cable or the power from the external drive while copying video clips. If the external drive is shut down or the USB cable is disconnected while copying video clips, THE DVR SYSTEM MAY NOT WORK NORMALLY OR THE EXTERNAL DRIVE COULD BE DAMAGED, and you will get an error message the next time you try to copy video clips. You will need to power down the DVR and restart it to get rid of the error message. Once the file system of the USB hard disk drive has been corrupted, this error message cannot be dismissed. Even after restarting the DVR it may automatically restart while preparing to clip copy. You must recover the file system using the recovery program, or you must reformat the hard disk drive.

Print

You can print images on a printer. Connect a PostScript™ printer, or external hard disk drive or flash drive to one of the USB ports.

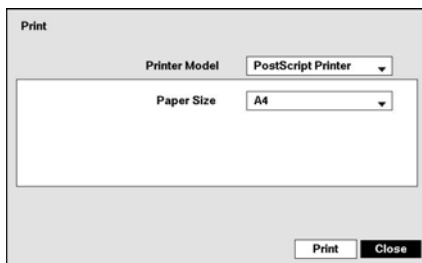

Highlight the box beside Printer Model and press the  button. Selecting PostScript Printer will print images on a PostScript™ printer connected to the DVR. Selecting File Printer will save the current image as a PDF file on an external USB hard disk drive or flash drive.

NOTE: Images saved as PDF files can be printed on any printer connected to your PC.





Highlight the box beside Paper Size and press the  button. You can select the paper size.

Figure 55 : Print screen.

Once you have selected the printer model and paper size, highlight the Print button and press the  button. A message appears asking you if you want to print the current image. Highlight the Continue button and press the  button to print.

NOTE: If your printer only supports an LPT connection (parallel), use an LPT to USB converter cable. The printer cable is not provided.

Disk Mirroring

The DVR supports disk mirroring to prevent unexpected loss of recorded video data that might be caused by disk damage or corruption. You can set up disk mirroring by highlighting **Storage** in the System menu and pressing the  button.

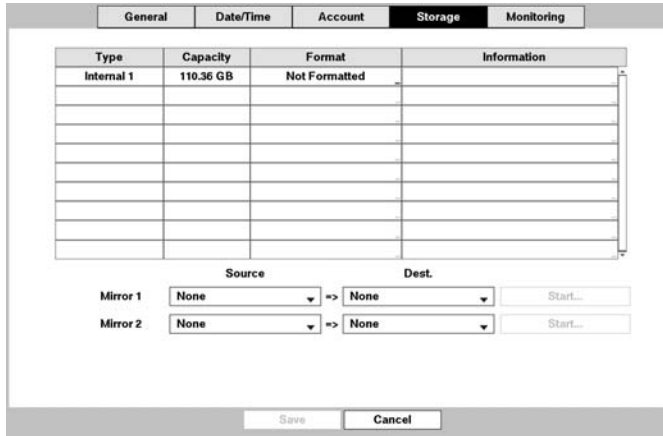



Figure 56 : System – Storage setup screen.

You can enable mirroring between two disks by designating the source disk and the destination disk from a list of internal hard disk drives. Up to two Mirrors are supported.

Highlighting the boxes under **Source** and **Dest.** and pressing the  button allows you to select the source disk and the destination disk for the selected Mirror.

NOTE: The source disk can be designated only from devices formatted for recording.

A device formatted for archiving cannot be used for disk mirroring.

The capacity of the destination disk should be the same or higher than the source disk for proper mirroring between the two disks.

CAUTION: Any existing data on the Destination Disk will be erased once it is designated as a mirror destination disk.

Highlighting **Start** and pressing the  button displays a confirmation screen asking you to confirm whether or not you want to start mirroring the selected disk. Once you start mirroring, the two disks will be resynchronized. Any data on the destination disk will be erased, and the data on the source disk will be copied to the destination disk. If the source disk is formatted and has no data, the disks will not be resynchronized. Resynchronization takes about 40 minutes per each 10GB of capacity. After resynchronization is complete, disk mirroring (writing data on the two disks at the same time) will start.

Once disk mirroring starts, you can cancel it by highlighting **Stop** and pressing the  button. Selecting **Stop** displays a confirmation screen asking you to confirm whether or not you want to stop mirroring for the selected disk.

NOTE: Once disk mirroring stopped, the destination disk will be set to *Not Used*. If resynchronization has been finished, the destination disk cannot be used for recording or archiving, but it can be used for searching. If you want to use the disk for recording or archiving, you must reformat it.

CAUTION: Disk mirroring will NOT automatically restart from an interrupted state. Once mirroring is stopped, you must restart it by following the mirroring setup procedures.

CAUTION: If disk mirroring fails, you must restart the system before trying disk mirroring again. When a disk mirroring failure is caused by a disk error, you must replace the disk with a new one.

Appendix

USB Hard Disk Drive Preparation

NOTE: The following description is for preparing a USB hard disk drive under Windows 2000. Preparing a USB hard disk drive under Windows XP, Window Vista and Window 7 is almost identical to Windows 2000.

1. Connect the USB hard disk drive to your computer using the USB Cable.
2. Turn on your computer.
3. The USB device icon should display on the Taskbar.
4. If the USB hard disk drive is partitioned or has data, it will show up in *My Computer* as a hard disk drive icon. Check the file system by right clicking on the icon and checking under *Properties > General > File System*. If the file system is NOT FAT32 format, format the USB hard disk drive using the FAT32 format.
5. If the USB hard disk drive is not partitioned, go to *Administrative Tools* in *Control Panel* and launch *Computer Management*. Open *Disk Management* in *Storage* and right click an unallocated region of the USB hard disk drive. Then, click *Create Partition*.
6. In the *Create Partition* wizard, click *Next* then *Primary Partition*, and follow the instructions on the screen. Make sure that the FAT32 is selected for the file system.

NOTE: The partition size should be less than 32GB because of Microsoft limitations.

After formatting is complete, the USB hard disk drive will be added to *My Computer*.

7. Connect the USB hard disk drive to the DVR.

Text-In Search Examples

Search Example I

1 2 3 4 5 6
12345678901234567890123456789012345678901234567890

Item	Unit price	Qty	amount
Coke	\$ 2.20	1(s)	\$ 2.20
Fanta	\$ 2.20	1(s)	\$ 2.20
Hotdog	\$ 3.50	3(s)	\$ 10.50
Pepsi	\$ 1.95	1(s)	\$ 1.95
total :			\$ 16.85

Thank you~~

In the above text-in data, you can find that the comparison value is located at 17th (Unit price, \$ mark will be ignored automatically), 28th (Qty) and 40th (amount) characters (including spaces) from the left. In this case, you can enter "17", "28" and "40" in each Column box.

For example, if you want to search for Coke with a Qty (Quantity) of more than 1 and Hotdog with an amount totaling over \$8, the following search condition can be set.

Text-In Search Option

From First 01-06-2011 14:26:30

To Last 01-06-2011 14:26:30

Channels 1-14

Generic Text

No.	-	Name	Comp.	Value	Column	Line	X
1		Coke	>	1	28	0	X
2	AND	Hotdog	>	8	40	0	X
					0	0	X
					0	0	X
					0	0	X

Case Sensitive

Load Save Search Cancel

Search Example II

1 2 3 4 5 6
 12345678901234567890123456789012345678901234567890

Item	Unit price	Qty	amount
Coke	\$ 2.20	1(s)	\$ 2.20
Fanta	\$ 2.20	1(s)	\$ 2.20
Hotdog	\$ 3.50	3(s)	\$ 10.50
Pepsi	\$ 1.95	1(s)	\$ 1.95
total :			\$ 16.85

Thank you~~

In the above text-in data, you can find that the comparison value is located at 17th (Unit price, \$ mark will be ignored automatically), 28th (Qty) and 40th (amount) characters (including spaces) from the left, but the value of amount category is located on a different line from Item. In this case, you can enter "17", "28" and "40" in each Column box and enter "1" in the Line box for the next line.

For example, if you want to search for Coke with a Qty (Quantity) of more than 1 and Hotdog with an amount totaling over \$8, the following search condition can be set.

Text-In Search Option

From First 01-06-2011 14:26:30

To Last 01-06-2011 14:26:30

Channels 1-14

Generic Text

No.	-	Name	Comp.	Value	Column	Line	X
1		Coke	>	1	28	0	X
2	AND	Hotdog	>	8	40	1	X
					0	0	X
					0	0	X
					0	0	X

Case Sensitive

Load Save Search Cancel

ATVision

ATVision allows you to access a remote DVR, monitor live video images and search recorded video using Internet Explorer web browser anytime from virtually anywhere.

Computer system requirements for using the ATVision program are:

- Operating System: Microsoft® Windows® XP x86 (32 Bit) (Service Pack 3), Microsoft® Windows® Vista x86 (32 Bit) (Service Pack 1), Microsoft® Windows® 7 x86 (32 Bit)
- CPU: Intel Pentium III (Celeron) 600MHz or faster
- RAM: 128MB or higher
- VGA: 8MB or higher (1024x768, 24bpp or higher)
- Internet Explorer: Version 6.0 or later

Start Internet Explorer on your local PC. You can run the ATVision program by entering the following information in the address field.

- “http://IP address:port number” (The DVR IP address and the ATVision port number (default: 12088) set in the Network setup screen (ATVision tab))
- Or, “http://DVRNS server address/DVR name” (The DVRNS server address and the DVR name registered on the DVRNS server)

NOTE: You will need to get the appropriate IP address for the DVR you want to connect to and the ATVision port number from your network administrator.

ATVision only works with Microsoft Internet Explorer and will NOT work with other browsers.

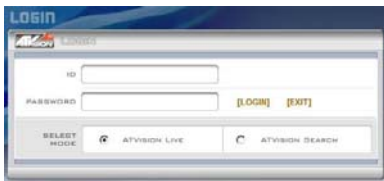

Select between the ATVISION LIVE (Web monitoring) and ATVISION SEARCH (Web search) modes. Entering ID and PASSWORD and clicking the [LOGIN] button logs in using the selected mode.

NOTE: Do NOT close the LOGIN window during the ATVision operation, otherwise, it will cause a script error when switching between Web monitoring and Web search modes, and you will need to restart the ATVision program.

When running the updated ATVision for the first time, Internet Explorer might occasionally load the information of the previous version. In this case, delete the temporary internet files by selecting Tools → Internet Options → General tab, and then run ATVision again.

There might be a problem that the bottom of ATVISION page is cropped due to the address or status bars in Microsoft Internet Explorer 7.0. In this situation, it is recommended that websites open windows without address or status bars by changing the internet setting. (Go to the Tools → Internet Options → Security tab → Click the Custom level... button → Select *Enable* for the *Allow websites to open windows without address or status bars* option)

When running ATVision in the Microsoft Windows Vista or higher operating system, it is recommended to start Internet Explorer with elevated administrator permissions. Click the right mouse button on the Internet Explorer icon and select the *Run as administrator* option from the context menu. Otherwise, some functions of the ATVision might be limited to use.

There might be a problem with screen display or screen update due to low image transmission speed when using the Microsoft Windows Vista or higher operating system. In this situation, it is recommended that you disable the Auto Tuning capability of your computer.

Run the *Command Prompt* with elevated administrator permissions (Go to the Start Menu → Accessories → Command Prompt → Click the right mouse button and select the *Run as administrator* option). Then enter “netsh int tcp set global autotuninglevel=disable” and hit the enter key. Restart your computer to apply the changes.

If you want to enable the Auto Tuning capability again, enter “netsh int tcp set global autotuninglevel=normal” after running the Command Prompt with elevated administrator permissions. Restart your computer to apply the changes.

Web Monitoring Mode

ATVISION LIVE is a remote web monitoring program that allows you to monitor live video transmitted in real-time from the remote DVR.

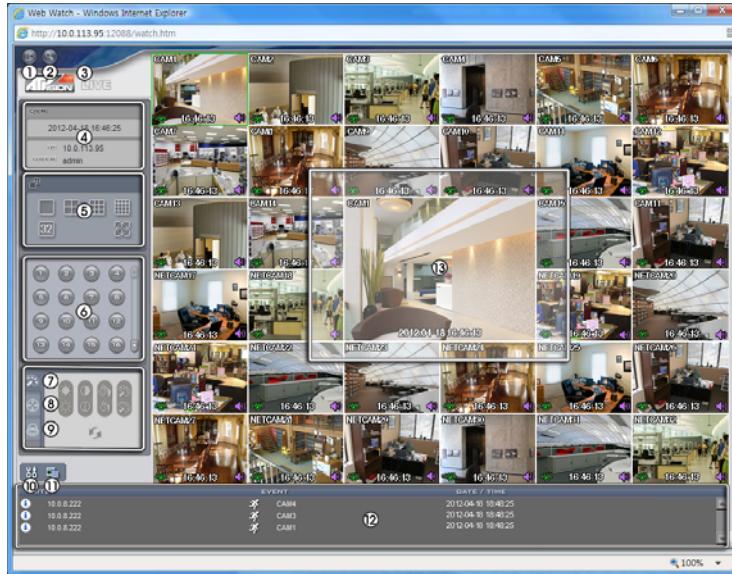

- ① Click the to log out the ATVISION program.
- ② Click the to access to the web search mode.
- ③ Position the mouse pointer on the ATVISION logo to see the version of the ATVISION program.
- ④ The DVR information window displays the login information of ATVISION.
- ⑤ Click the screen format to select the desired display mode. When changing the screen format, the selected camera on the current screen will be located in the first cell of the new layout.
- ⑥ Click the camera button to select the camera to be viewed.
- ⑦ Click the to adjust the brightness, contrast, saturation and hue of monitoring image.
- ⑧ Click the to control pan, tilt and zoom of the camera from a remote site.
- ⑨ Click the to control alarm out devices at the remote site.

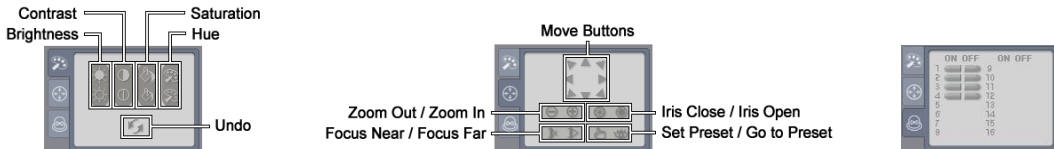

- ⑩ Click the to set up the image drawing mode, OSD display and beep on/off. You can adjust the display speed by changing the image drawing mode, select OSD information to be displayed on the screen, and turn the DVR's internal buzzer on and off from a remote site.
- ⑪ Click the to save the current image as a bitmap or JPEG file format.
- ⑫ The event status window at the bottom displays a list of events that were detected from the remote site.
- ⑬ Selecting a camera on the screen and clicking the right mouse button displays the text menu screen.



- **Change Camera Title:** Changes the camera name.
- **Enable Audio:** Enables audio communication with the remote site. When the audio control panel displays, click the to send audio to the connected remote site and click the button again to stop sending audio. Click the to monitor live audio from the connected remote site through the attached speaker and click the button again stop monitoring live audio. Clicking both and allows two-way communication. Clicking the disables audio communication.
- **Aspect Ratio:** Changes the image aspect ratio.
- **Deinterlacing:** Using a deinterlace filter for interlaced video enhances image display quality by eliminating horizontal scan lines and noise in areas with motion.
- **Anti-Aliasing Screen:** Enhances image display quality by eliminating stair stepping (aliasing) effects in the enlarged image.

NOTE: A camera name change in the Web Watch mode does not affect the camera name set up on the remote site. Leaving the Camera Title blank causes the camera name set up on the remote site to display.

The icon will display on each camera screen when audio communication is available between the ATVision system and a DVR.

Web Search Mode

ATVISION SEARCH is a remote web search program that allows you to search recorded video on the remote DVR.

NOTE: The remote site connection in the Web Search mode will automatically be disconnected if there is no activity for 30 minutes.

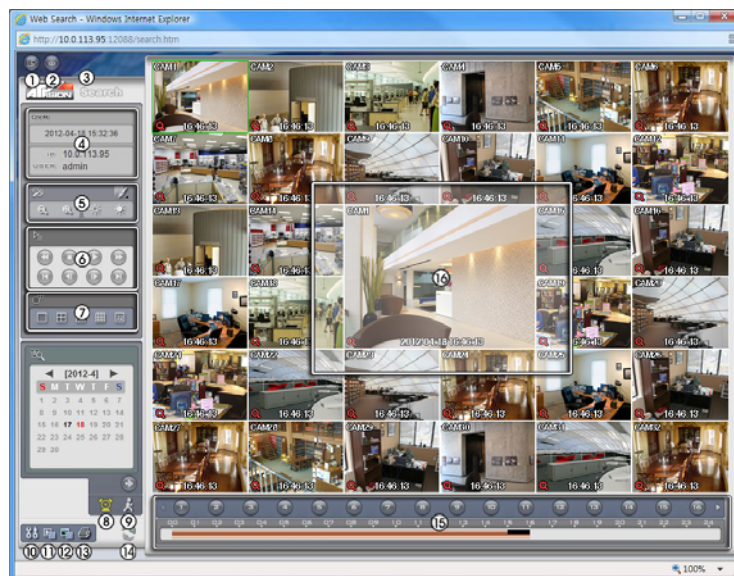

- ① Click the to log out the ATVision program.
- ② Click the to access to the web monitoring mode.
- ③ Position the mouse pointer on the ATVISION logo to see the version of the ATVision program.
- ④ The DVR information window displays the time information of recorded data on the remote DVR and login information of ATVision.

- ⑤ Click the to blur, sharpen, equalize and interpolate playback images. Click the to zoom out or zoom in the recorded image. Click the to adjust the brightness of the recorded images.



NOTE: Image processing works only in the pause mode.

- ⑥ The playback function buttons include fast backward, pause, play, fast forward, go to the first image, go to the previous image, go to the next image, and go to the last image.
- ⑦ Click the screen format to select the desired display mode.
- ⑧ Click the to enter the time-lapse search mode which allows you to search for recorded data by time and then play back images found within the time parameters. The Timetable window located at the bottom displays the time information for the image of the date selected on the calendar. If more than one video stream in the same time range, you can select the video stream you want to search. Clicking a specific time displays the image recorded at that time on the screen. Selecting the allows you to display an image from a specific time.

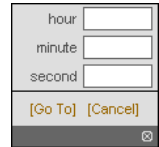

- ⑨ Click the to enter the event search mode which allows you to search for event log entries using specific conditions and play back the images associated with those event entries.
- ⑩ Click the to set up the image drawing mode and OSD display. You can adjust the display speed by changing the image drawing mode, and select OSD information to be displayed on the screen.
- ⑪ Click the to save any video clip of recorded data as an executable file.
- ⑫ Click the to save the current image in a bitmap or JPEG file format.
- ⑬ Click the to print the current image on a printer connected to your computer.
- ⑭ Click the to reload the recording data.
- ⑮ The Timetable displays recorded data of the selected camera by time (in hour segments).
- ⑯ Selecting a camera on the screen and clicking the right mouse button displays the text menu screen.



- **Change Camera Title:** Changes the camera name.
- **Enable Audio:** Plays audio while playing back recorded video that has recorded audio. (Single-Screen Layout Only)
- **Aspect Ratio:** Changes the image aspect ratio.
- **Deinterlacing:** Using a deinterlace filter for interlaced video enhances image display quality by eliminating horizontal scan lines and noise in areas with motion.
- **Anti-Aliasing Screen:** Enhances image display quality by eliminating stair stepping (aliasing) effects in the enlarged image.

NOTE: A camera name change in the Web Search mode does not affect the camera name set up on the remote site. Leaving the Camera Title blank causes the camera name set up on the remote site to display.

Time Overlap

If the DVR's time and date have been reset to a time that is earlier than the existing recorded video, it is possible for the DVR to have more than one video stream in the same time range. In this case, you can search overlapping video streams individually by selecting a specific segment. For example, when the DVR has recorded video from one to five o'clock and the user changes the time backward from five to three o'clock and then continues recording until six o'clock, there will be two video streams and segments from three to five o'clock.

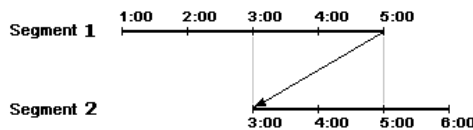

You can search overlapping video streams by selecting a specific time or time range. If you want to search recorded video at four o'clock during the overlapping time range using a search menu such as Go to the Date/Time, select the segment you want to search.



If you want to search recorded video from four to five o'clock during the overlapping time range using a search menu such as Event Log Search, Text-In Search or Motion Search, it is possible for the DVR to have two overlapping start and stop times. You will be asked to select one of the overlapping start and stop times from the search time ranges as follows:

- From four o'clock of the first segment to five o'clock of the first segment
- From four o'clock of the first segment to five o'clock of the second segment
- From four o'clock of the second segment to five o'clock of the second segment

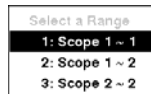

Remote Setup of Network Devices

The following describes how to set up the network devices using the ONVIF™ Conformance protocol on the DVR. While in the Live Monitoring mode, press the **MENU** button and move to the Camera menu and then to Network Camera setup. In the Network Camera setup screen, highlight the box under the Settings heading and press the **←** button.

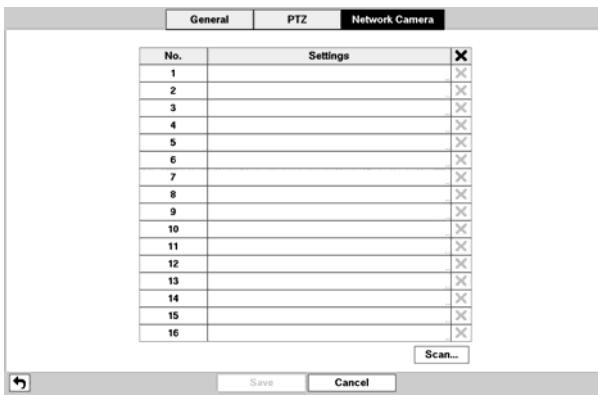

Highlight the Device Remote Setup box and press the **←** button. The Device Remote Setup screen appears.

NOTE: The setup menu and options may differ depending on the device model. Refer to the network device manufacturer's documentation for correct device settings.

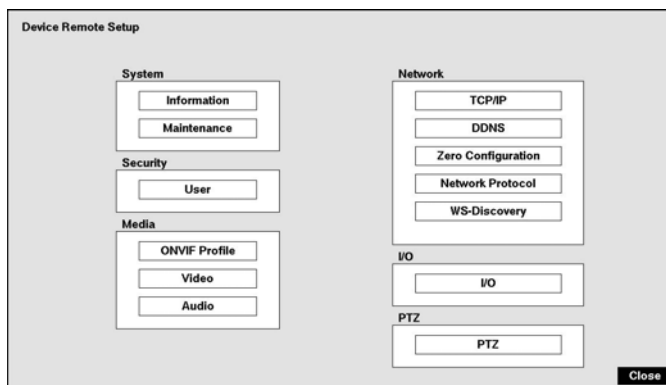

System Setup



- Information: Displays the device information.
- Maintenance: Restarts the device or returns all device settings to the original factory settings.

Security Setup



- User: Adds or deletes a user.

Media Setup

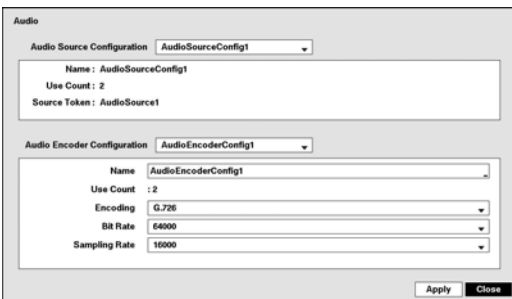
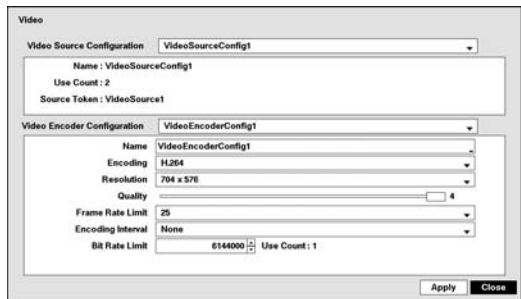
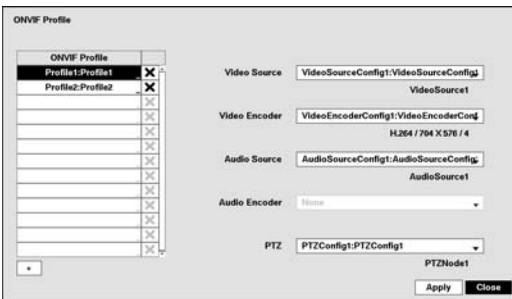

- ONVIF Profile: Adds or deletes an ONVIF™ profile.
- Video: Sets up the video source and encoder. The frame rate cannot exceed 15 ips when recording video with the H.264 codec and 4CIF resolution if the device is a network video transmitter.
- Audio: Sets up the audio source and encoder.

Network Setup

TCP/IP
IP Address Configuration

Type: **Manual**

IP Address: 10.0.123.230
Default Gateway: 10.0.0.11

DNS Configuration

Type: **Manual**

Domain Name: NCP103@seunghb
Primary DNS: 10.0.0.23
Secondary DNS: 0.0.0.0

Apply Close

DDNS

Update Type: Client Update

Name:
TTL: 30

Apply Close

Zero Configuration

Zero Configuration

IP Address

Apply Close

Network Protocol

HTTP Server Port: 80
HTTPS Server Port: 443
RTSP Server Port: 554

Apply Close

WS-Discovery

Scope Parameters

Discovery Mode: Discoverable

Apply Close

- TCP/IP: Sets up the device's IP address and DNS server.
- DDNS: Sets up the DDNS function.
- Zero Configuration: Automatically allocates an appropriate IP address for the current network conditions (supported only for devices that provide the function).
- Network Protocol: Changes the port numbers for the network protocols that are used in the device (supported only for the protocols that are used in the device).
- WS-Discovery: Sets up the WS-Discovery function.

I/O Setup

I/O

Name	Mode	Delay Time	Idle State	Action	Action
root.IOPort.I1.Output	Bistable	0	Close	Active	Inactive
				Active	Inactive
				Active	Inactive
				Active	Inactive
				Active	Inactive
				Active	Inactive
				Active	Inactive
				Active	Inactive

Apply Close

- I/O: Sets up the input and output devices.

PTZ Setup

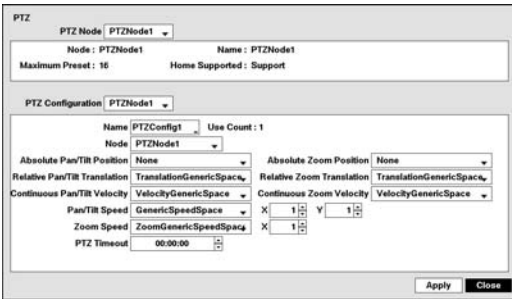

- PTZ: Sets up the PTZ.

Connector Pin Outs

RS485 Connector Pin Outs



Master Unit		Slave Unit	
+	→	To	→ TX+/ RX+
-	→	To	→ TX-/ RX-

I/O Connector Pin Outs

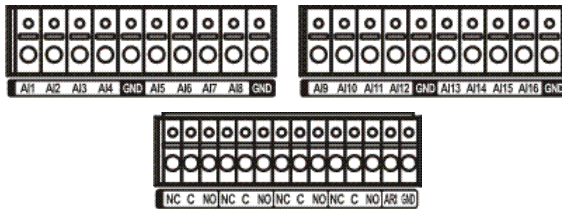





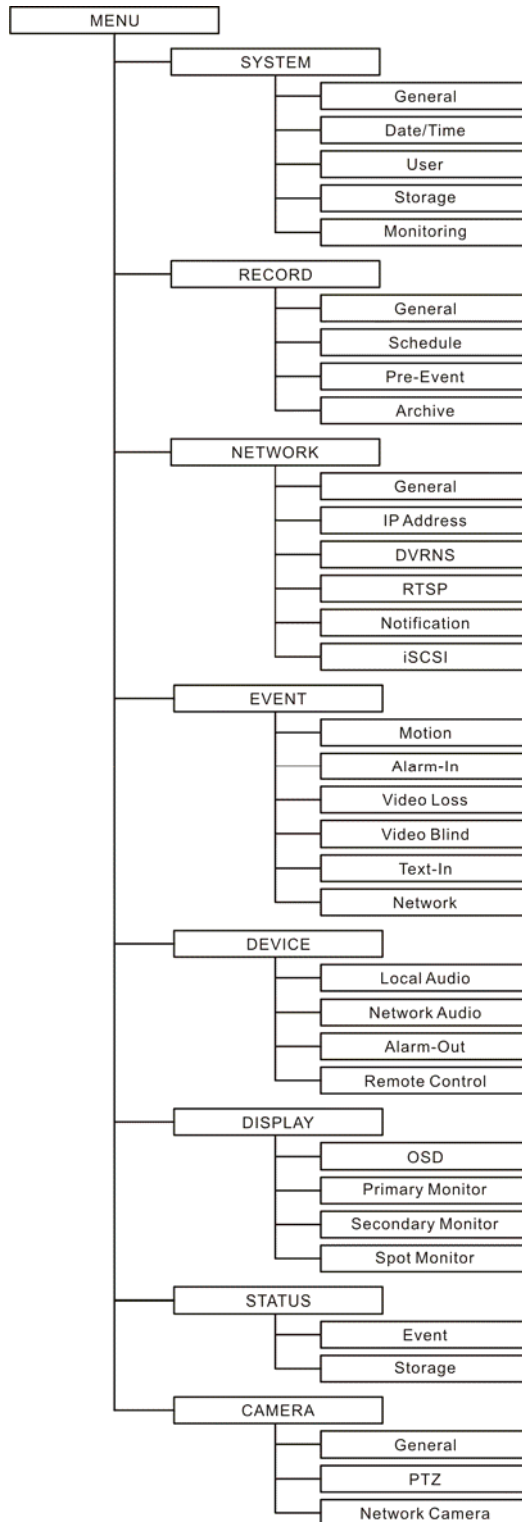

AI (1 to 16)	Alarm Inputs 1 to 16
GND	Chassis Ground (5 connectors)
NC	Relay Alarm Output (Normally Closed)
C	Relay Common
NO	Relay Alarm Output (Normally Open)
ARI	Alarm Reset In

Map of Screens



Troubleshooting

Problem	Possible Solution
No Power	<ul style="list-style-type: none"> • Check power cord connections. • Confirm that there is power at the outlet.
No Live Video	<ul style="list-style-type: none"> • Check camera video cable and connections. • Check monitor video cable and connections. • Confirm that the camera has power. • Check camera lens settings.
No Video on the Primary Monitor	<ul style="list-style-type: none"> • Check the current primary monitor resolution. • Check the position of the HD/SD Out selector on the rear panel of the DVR. <ul style="list-style-type: none"> - HDMI video out on the primary monitor will only enable in the HD display mode. - VGA video out on the primary monitor will disable in the SD display mode. - Composite (BNC) video out on the primary monitor will disable in the HD display mode.
Changing the screen format is not applied on the monitor screen	Check the current monitor mode by pressing the MONITOR button on the front panel or by selecting the  (Monitor) in the Live Monitoring menu. Changing the screen format will be applied only on the selected monitor.
Live Video Very Bright	If a cable is attached to the “Loop” connector, make certain it is connected to a properly terminated device.
DVR has stopped recording	If hard disk drive is full, you will either need to delete video or set the DVR to the Overwrite Mode.
The icon  displays, however, the DVR is not recording.	When the DVR is in the Pre-Event recording mode, the yellow  and  display when there is no event, and the DVR is not recording. The red  and  display when any event occurs and the DVR starts recording.
While upgrading the system, the DVR keeps rebooting and the upgrade fails.	If the current system version is higher than the upgrade package file version, you should reset the DVR first using the Factory Reset. When using the Factory Reset, you will lose any settings you have saved.

System Log Notices

Boot Up	Setup Exported	Clip-Copy From:
Shutdown	Setup Export Failure	Clip-Copy To:
Restart	Setup Export Cancel	Clip-Copy Duration of Video:
Upgrade	Schedule On	Clip-Copy Camera:
Upgrade Fail	Schedule Off	Callback Fail
Power Failure	Panic On	Print Begin
Time Change	Panic Off	Print End
Time Zone Change	Clear All Data	Print Cancel
Time Sync	Clear Disk	Archive On
Time Sync Fail	Format Disk	Archive Off
Disk Bad	Disk Full	Mirror 1 (2) Started
Login	Auto Deletion	Mirror 1 (2) Start Failed
Logout	Search Begin	Mirror 1 (2) Stopped
Setup Begin	Search End	Mirror 1 (2) Stop Failed
Setup End	Clip-Copy Begin	Factory Reset
Remote Setup Change	Clip-Copy End	Login : VNC (server address)
Remote Setup Failure	Clip-Copy Cancel	Logout : VNC (server address)
Setup Imported	Clip-Copy Fail	
Setup Import Failure	Clip-Copy User:	

Error Code Notices

System Upgrade Related		Clip Copy Related	
No.	Description	No.	Description
0	Unknown error.	0	Unknown error.
1	File version error.	1	Device error.
2	Operating system version error.	2	Mounting failed.
3	Software version error.	3	No media.
4	Kernel version error.	4	Invalid media.
100	Upgrade device mounting failed.	5	File already existed.
101	Package is not found.	6	Not enough space.
102	Extracting package failed.	7	Creating temporary file failed.
103	LILO failed.	8	Opening disk failed.
104	Rebooting failed.	9	Formatting disk failed.
105	Invalid package.	10	Database has been changed.
106	ODD firmware upgrade failed.	11	Appending failed.
300	Remote connection failed.	12	Bad sector.
301	Remote network error.	13	No executable file.
302	Remote upgrade is not authorized.	14	Opening executable file failed.
303	Saving remote package failed.	15	Writing executable file failed.
304	Remote upgrade is cancelled by the user.	16	Creating image failed.
400	USB device mounting failed.	17	Burning failed.
401	Reading upgrade package on the USB device failed.	18	Burning is out of time.
402	Copying upgrade package on the USB device failed.	19	Connecting device failed.
403	USB device is not connected.	20	Device is busy.
404	USB device is being used.	21	Unsupported file system.
405	Unsupported file system.	22	Verify failed.
500	System is busy clip copying.	23	No Recorded Data

Connection Failure Related (Network Devices Only)			
No.	Description	No.	Description
0	Unknown case.	20	Connection has been canceled by user.
1	Normal logout.	21	Peer host does not respond.
2	Connection denied – all server channels are in use.	22	Network is too noisy.
3	Invalid product version.	23	Sending queue overflow.
4	Invalid user or password.	24	Invalid OEM number.
5	Admin forcibly closed the current connection.	25	You have no authority for search.
6	Timeout.	26	Port is already in use.
7	Post system shutdown.	27	SSL connection failed.
8	Cannot connect – all network channels are in use.	28	Network timed out.
9	Cannot connect – no server module.	29	Host timed out.
11	Network is down.	30	Host cannot support RTP over TCP.
12	Network is unreachable.	31	Socket error occurred.
13	Connection timed out.	100	Unknown codec.
14	Connection reset by peer.	101	JPEG codec.
15	Host is down.	103	MPEG4 codec.
16	No route to host.	400	Unsupported resolution.
17	Connection aborted.	-1	Connection normal.

Specifications

VIDEO		
Signal Format	NTSC or PAL (Auto Detect)	
Video Input	Local	Composite: 16 looping inputs, 1 Vp-p, auto-terminating, 75 Ohms
	Network	16 network devices (100Mbps/1Gbps Ethernet)
Monitor Outputs	Primary Monitor HDMI: 1 HDMI VGA: 1 Composite: 1 BNC, 1 Vp-p, 75 Ohms	
	Secondary Monitor VGA: 1 Composite: 1 BNC, 1 Vp-p, 75 Ohms	
	SPOT: 1 BNC, 1 Vp-p, 75 Ohms	
Video Resolution	Primary Monitor HDMI: 1920x1080, 1680x1050, 1600x900, 1440x900, 1280x1024 VGA: 1920x1080, 1680x1050, 1600x900, 1440x900, 1280x1024 Composite: 720x480 (NTSC), 720x576 (PAL)	
	Secondary Monitor VGA: 800x600 Composite: 720x480 (NTSC), 720x576 (PAL)	
	Composite (SPOT): 720x480 (NTSC), 720x576 (PAL)	

VIDEO	
Record Speed (images per second)	480ips (NTSC), 400ips (PAL) @ D1 (Real-time) Network Device: 70ips @ 1920x1080 / 110ips @ 1280x720
Playback Speed (images per second)	480ips (NTSC), 400ips (PAL) @ CIF (Full Duplex)

INPUTS/OUTPUTS		
Alarm Input	16 terminal, programmable as NC or NO, 2.4V (NC) or 0.3V (NO) threshold, 5VDC	
Alarm Output	4 relay output, programmable as NC or NO, 2A@125VAC, 1A@30VDC	
Alarm Reset Input	1 TTL, terminal block	
Internal Buzzer	80dB at 10cm	
Network Connectivity	10Mbps/1Gbps Ethernet (RJ-45)	
Audio Input	Local	RCA Input, 16 Line In
	Network	16, 100Mbps/1Gbps Ethernet
Audio Output	RCA Output: 1, Line Out	
Text Input	POS Interface, ATM Interface	

CONNECTORS		
Video Input	Local	Composite: 16 BNC
	Network	RJ-45 (100Mbps/1Gbps Ethernet)
Video Loop		Composite: 16 BNC (Auto Terminating)
Monitor Output		HDMI: 1 HDMI Composite: 1 BNC VGA: 1 VGA SPOT (Composite): 1 BNC
Audio In	Local	16 RCA connector
	Network	RJ-45 (100Mbps/1Gbps Ethernet)
Audio Out		1 RCA connector
Alarm Input/Output		Terminal Blocks
Ethernet Port		2 RJ-45
eSATA Port		eSATA
RS232C Serial Port		DB9 (P)
RS485 Serial Port		Two-connector terminal block
IR Port		1 Remote Control
USB Port		2 (USB 2.0)

STORAGE	
Primary Storage	SATA hard disk drive (up to 5) (up to 4 with an eSATA hard disk drive)
Secondary Storage*	eSATA hard disk drive (RAID) iSCSI hard disk drive (RAID) Built-in DVD RW drive USB hard disk drive or flash drive

* When installing an internal DVD RW drive, connect the SATA I/O cable to the SATA ODD socket.

GENERAL	
Dimensions (W x H x D)	16.9" x 3.5" x 19.3" (430mm x 88mm x 490mm)
Unit Weight	22.9 lbs. (10.4kg)
Shipping Weight	30.9 lbs. (14.0kg)
Shipping Dimensions (W x H x D)	26.9" x 10.7" x 21.2" (683mm x 271mm x 538mm)
Operating Temperature	41°F to 104°F (5°C to 40°C)
Operating Humidity	0% to 90%
Power	100 to 240 VAC, 2.0 – 1.0 A, 50/60Hz
Power Consumption	Max. 100W
Approvals	FCC, UL**, CB, CE

** CAUTION: Risk of Explosion if Battery is replaced by an Incorrect Type. Dispose of Used Batteries According to the Instructions. This equipment is indoor use and all the communication wiring are limited to inside of the building.

Specifications are subject to change without notice.