

PRODUCTION RELEASE & REVISION						
REV	DESCRIPT'N/BUYER	DWG No	PARTS No.	BY	CHK	DATE
A	INITIAL	-----	50303703	J.Y.LIU	M.J.KWON	14-02-06

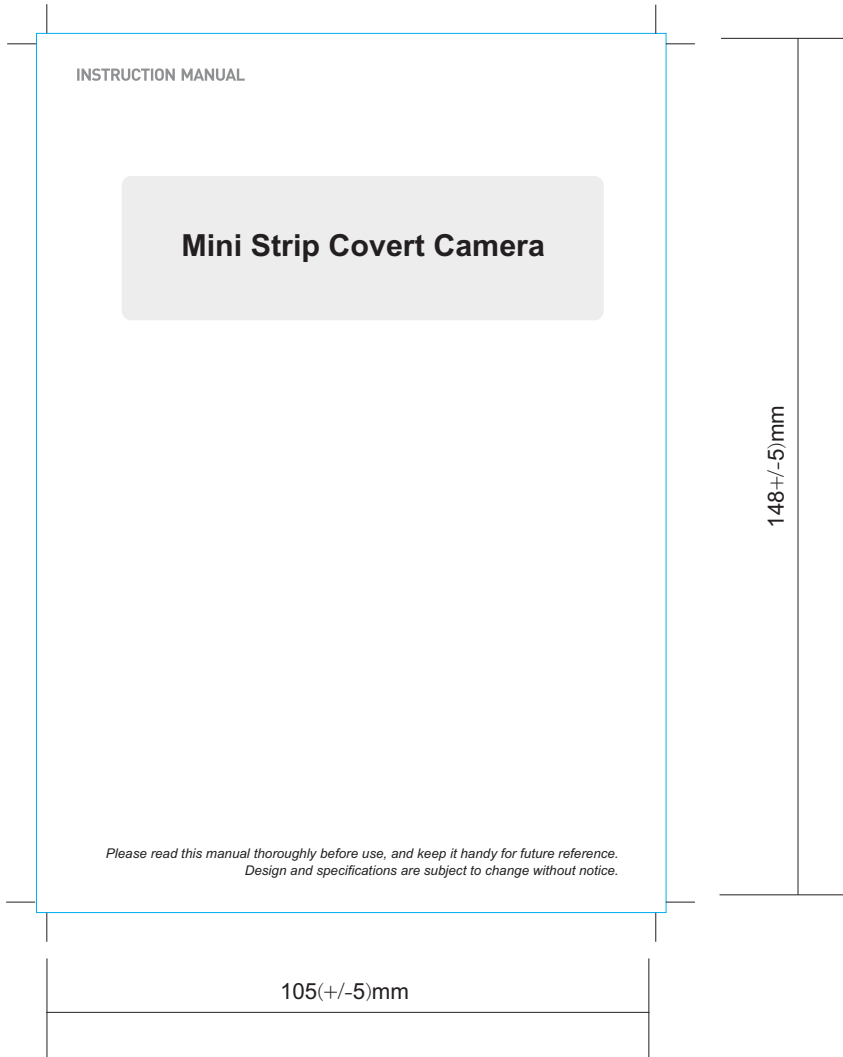

NOTES

- 1.MODEL: **HCE-N41KNF3SM(960H mini-strip)**
- 2]MATERIAL: 모조지 100g/m² WHITE
- 3]COLOR: BLACK
- 4.SIZE: 105(+/-5)mm x 148(+/-5)mm
- 5.LABEL: -----
- 6.ANY CHANGE OR ALTERNATION MUST BE APPROVED BY HITRON DESIGN TEAM.

의 내 역	전자	
	장경석	
	14-02-06	

50303703		ITEM	DESCRIPTION/MATERIAL	QTY
UNLESS OTHERWISE SPECIFIED ALL DIMENSIONS ARE IN MM.		PARTS LIST		
- TOLERANCE	LABEL +/- 3 MANUAL +/- 5 GUIDE +/- 5	APPROVALS	DATE	 Instruction Manual
MATERIAL		J.H.JUNG	14-02-06	
	2	CHKED	M.J.KWON	14-02-06
COLOR	3	DRAWN	J.Y.LIU	14-02-06
		SIZE	A4	REV. A
SCALE: DO NOT SCALE				

Mini Strip Covert Camera

*Please read this manual thoroughly before use, and keep it handy for future reference.
Design and specifications are subject to change without notice.*

FCC COMPLIANCE STATEMENT

This device complies with Part 15 of the FCC Rules. Operation is subject to the following two conditions: (1) this device may not cause harmful interference, and (2) this device must accept any interference received, including interference that may cause undesired operation.

FCC INFORMATION : This equipment has been tested and found to comply with the limits for a Class A digital device, pursuant to Part 15 of the FCC Rules. These limits are designed to provide reasonable protection against harmful interference when the equipment is operated in a commercial environment. This equipment generates, uses, and can radiate radio frequency energy and, if not installed and used in accordance with the instruction manual, may cause harmful interference to radio communications. Operation of this equipment in a residential area is likely to cause harmful interference in which case the user will be required to correct the interference at his own expense.

CAUTION : Changes or modifications not expressly approved by the party responsible for compliance could void the user's authority to operate the equipment.

CE COMPLIANCE STATEMENT

WARNING : This is a Class A product. In a domestic environment this product may cause radio interference in which case the user may be required to take adequate measures.

IMPORTANT SAFETY INSTRUCTIONS

1. Read these instructions.
 2. Keep these instructions.
 3. Heed all warnings.
 4. Follow all instructions.
 5. Do not block any ventilation openings. Install in accordance with the manufacturer's instructions.
 6. Do not install near any heat sources such as radiators, heat registers, stoves, or other apparatus (including amplifiers) that produce heat.
 7. Only use attachments/accessories specified by the manufacturer.
 8. Use only with the cart, stand, tripod, bracket, or table specified by the manufacturer, or sold with the apparatus. When a cart is used, use caution when moving the cart/ apparatus combination to avoid injury from tip-over.
- 
- 9. CAUTION - THESE SERVICING INSTRUCTIONS ARE FOR USE BY QUALIFIED SERVICE PERSONNEL ONLY. TO REDUCE THE RISK OF ELECTRIC SHOCK DO NOT PERFORM ANY SERVICING OTHER THAN THAT CONTAINED IN THE OPERATING INSTRUCTIONS UNLESS YOU ARE QUALIFIED TO DO SO.**
- 10. Use satisfy clause 2.5 of IEC60950-1/UL 60950-1 or Certified/Listed Class 2 power source only.**
11. Indoor use only.

EXPLANATION OF GRAPHICAL SYMBOLS



The lightning flash with arrowhead symbol, within an equilateral triangle, is intended to alert the user to the presence of uninsulated "dangerous voltage" within the product's enclosure that may be of sufficient magnitude to constitute a risk of electric shock to persons.



The exclamation point within an equilateral triangle is intended to alert the user to the presence of important operating and maintenance (servicing) instructions in the literature accompanying the product.

INTRODUCTION

Features:

- High resolution and high performance 1/3" Color CCD
- Excellent picture quality
- 700 lines of resolution(Color)
- 0.1 lux(Color), 0.04ux(B/W) @ F1.2 50IRE Sensitivity
- Auto electronic shutter [1/60(1/50) ~ 1/100,000]
- Auto white balance
- AGC (Auto Gain Control)
- Use Certified / Listed Class 2 power source only
- 2D DNR(Digital Noise Reduction)
- Side Light Compensation
- 3.7mm Pin hole Lens
- BNC (Video connection) 2-Pin terminal block (Power)
- Operates in DC12~15V +/- 10%



IMPORTANT : The user of this camera is responsible for checking and complying with local, state, and federal laws and statutes concerning the recording and monitoring of audio signals.

Step 1

The gimbal mount surface mounted to ceiling.

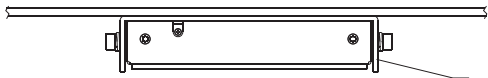

Default position out of the box is for vertical orientation of the camera view.

For horizontal orientation of camera the housing must be opened by removing the 4, M3 button head screws located on each side of the housing.

Camera module rotates 90 degrees in the desired direction.

* The gimbal mount surface mounted vertically.

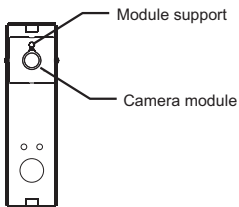

* The gimbal mount surface mounted horizontally.

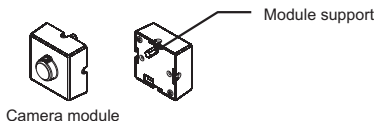

Open the box and unwrap the camera housing. Remove the top and bottom M6 Allen head screws and separate the gimbal mount from the housing.

Drill a feet-thru hole for the camera cable on the mounting surface.

Step 2

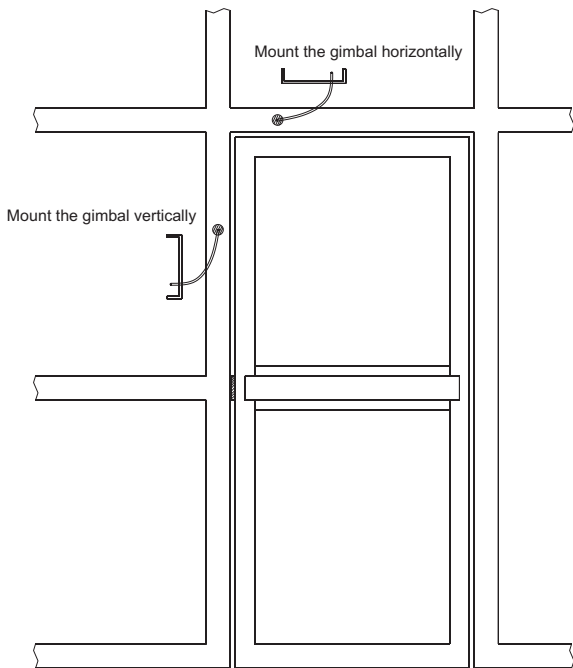

Feed wire through the 3/4" hole on the gimble mount.

For vertical mounting penetrate door frame at 63 inches from the finished floor.

The gimbal can be mounted on the top door jam if required.

Step 3

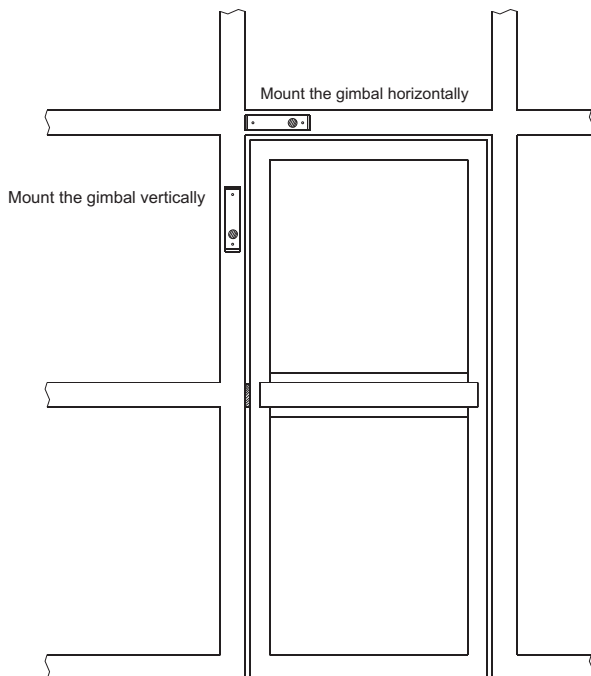

Center the gimbal mount to mounting surface and mark the mounting holes for the gimbal mount on the surface.

Secure the gimbal mount to the surface using installer supplied self tappers for aluminum frame structure.

If mounting on soft surface such as drywall be sure to use to use anchors.

For drop ceiling tiles it is recommended that toggle bolts be used as anchors.

Step 4

Completing the housing installation

Pull cable from headend thru the mount gimbal mount. Connect BNC connectors and mark power connection to the camera.

Note: Polarities must be observed the camera is 12V DC and damage will result if power polarities are not observed. Power connector has a positive center pin.

Mount the housing to the gimbal using the M6 Allen head screws at the top and bottom.

Place the external tooth washer between the housing and the gimbal mount then the split lock washer on the M6 screw and insert the screw into the housing through the gimbal mount and external tooth lock washer.

Adjust the camera housing right or left to acquire the proper field of view for the installation.

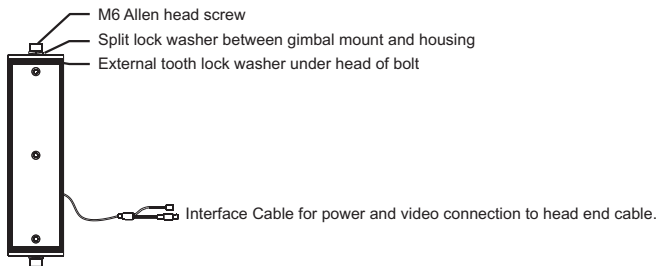

* Camera lens position can be adjusted up and down 5 degrees

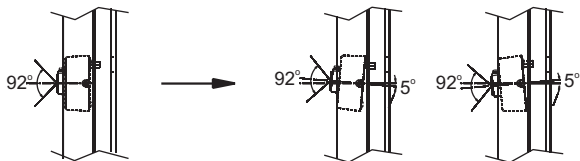

DIMENSIONS

MINI STRIP CAMERA

Unit: inch

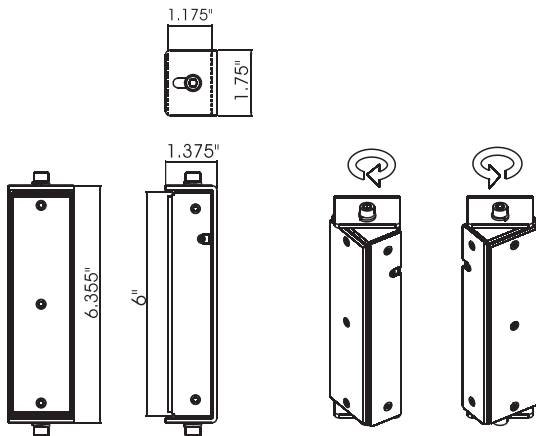

SPECIFICATIONS

	MODEL	NTSC	PAL
Power	Power source	DC12~15V +/-10%	
	Power consumption	130mA (1.5 Watts)	
General	Image sensor	1/3" Color CCD	
	Number of pixels	976(H) x 494(V)	976(H) x 582(V)
	Scanning system	2:1 interlace	
	Scanning frequency	15.734KHz(H) x 59.94Hz(V)	15.625KHz(H) x 50Hz(V)
	Sync. system	Internal	
	Electronic shutter	1/60 ~ 1/100,000 sec.	1/50 ~ 1/100,000 sec.
	Resolution	700 TV lines (Color)	
	Min. illumination	0.1 lux(COLOR), 0.04 lux(BW) @ F1.2, 50 IRE	
	Side Light Compensation	Auto	
	Digital Noise Reduction	2D DNR	
	Video output	1.0 Vp-p (75 ohm, composite)	
	S/N ratio	More than 50dB (AGC off)	
	Connector & etc.	AGC	ON
Day / Night		Auto	
White Balance		Auto(ATW)	
Power input		Terminal Block	
Video output		BNC Connector	
Lens mount		Fixed mount	
Lens		F3.7mm Pin hole Fixed	
Operating Temperature		-10°C ~ +50°C [14°F ~ 122°F]	
Operating humidity		0 ~ 96% (non-condensing)	
External Dimension		1.8"(W) x 6.4"(H) x 1.4"(D)	
Weight	set : 325g packing : 535g		

* Use the power consumption 2W over.

Mini Strip Covert Camera

PRINTED IN KOREA
